

Our Scalers

Compare our scalers and curettes with the best in the industry and you will immediately recognize we are equal in every way but one... price. Note the deep precision knurling for better tactile feel. The same high-grade stainless steel tips, the same light weight (under 18 grams) for less hand fatigue, the same professional craftsmanship, and surpassing the highest industry standards. of course, any manufacturer can make these claims, but we guarantee and certify ours.

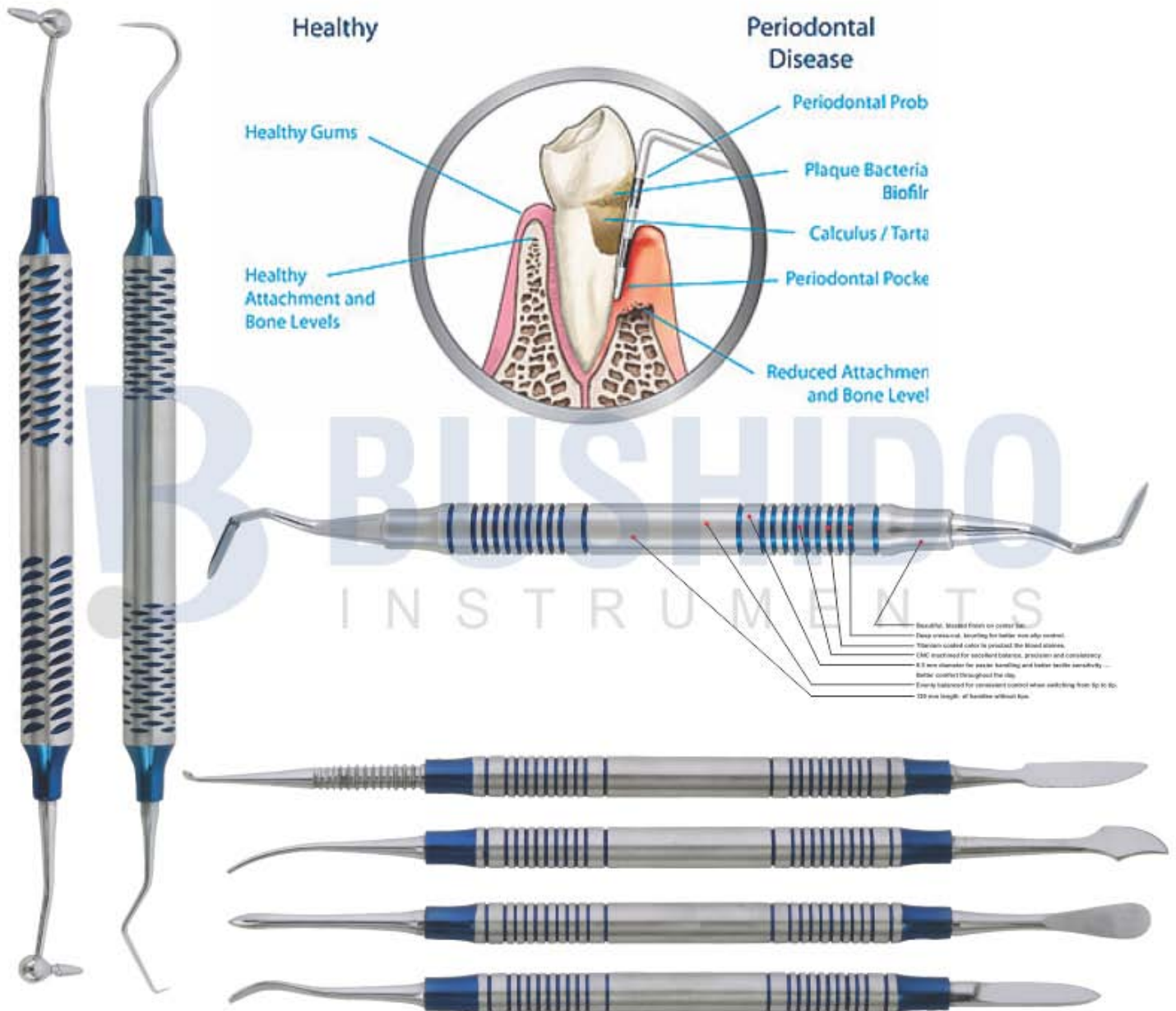

- High-polish mirror finish tips.
- Manufactured within the guidelines of the FDA quality assurance system for good manufacturing practices.
- Highest grade German stainless steel, razor sharp, durable tips. Rockwell hardened to 60 RHc.
- 27 of the most popular designs from gracesys to McCalls to columbias, and many european patterns.
- All instruments are guaranteed against defects in material and workmanship.

- All instruments bear the ce mark, emblematic of the european community's highest standards.
- Customer satisfaction guarantee, too!
- Less than 20 grams ... Lightweight for less hand fatigue.
- Manufactured to the most exacting standards so the 50th instrument you buy is exactly like your first.
- You decide ... Why pay more for the same high-quality instruments?

VALUED BUYERS

Compare our scalers and curettes with the best in the industry and you will immediately recognize we are equal in every way but one... price. Note the deep precision knurling for better tactile feel. The same high-grade stainless steel tips, the same light weight (under 20 grams) for less hand fatigue, the same professional craftsmanship, and surpassing the highest industry standards. Of course, any manufacturer can make these claims, but we guarantee and certify ours. We regularly manufacturing below articles in showing handles & pattern A to L for better grip & perfection. We are also fully equipped & capable to develop these instruments as per your own specific requirements & demands in materials, sizes, shapes and patterns.

**A-Hollow Handle Ø 10 mm****B-Hollow Handle Ø 10 mm****C-Hollow Handle Ø 10 mm****D-Hollow Handle Ø 10 mm****E-Hollow Handle Ø 10 mm****F-Hollow Handle Ø 10 mm****G-Hollow Handle Ø 10 mm****H-Hollow Handle Ø 6.4 mm****I-Hollow Handle Ø 8 mm****J-Hollow Handle Ø 10 mm****K-Soild Handle Ø 6 mm****L-Soild Handle Ø 6 mm**

MOUTH MIRRORS

- зеркал
- Espejos de la boca
- Mundspiegel
- дзеркал
- Miroirs à la bouche
- مرايا الفم

Plain



DE-600 Fig. 3 Ø20mm
DE-601 Fig. 4 Ø22mm
DE-602 Fig. 5 Ø24mm
DE-603 Fig. 6 Ø26mm



Cone-Socket Plain



DE-604 Fig. 3 Ø20mm
DE-605 Fig. 4 Ø22mm
DE-606 Fig. 5 Ø24mm

Magnifying



DE-607 Fig. 3 Ø20 mm
DE-608 Fig. 4 Ø22 mm
DE-609 Fig. 5 Ø24 mm



Cone-Socket Magnifying



DE-610 Fig. 3 Ø20mm
DE-611 Fig. 4 Ø22mm
DE-612 Fig. 5 Ø24mm

Rhodium



DE-613 Fig. 3 Ø20mm
DE-614 Fig. 4 Ø22mm
DE-615 Fig. 5 Ø24 mm



Cone-Socket Rhodium



DE-616 Fig. 3 Ø20mm
DE-617 Fig. 4 Ø22mm
DE-618 Fig. 5 Ø24mm

Front Surface



DE-619 Fig. 3 Ø20mm
DE-620 Fig. 4 Ø22mm
DE-621 Fig. 5 Ø24mm
DE-622 Fig. 6 Ø26mm



Cone-Socket Front Surface



DE-623 Fig. 3 Ø20mm
DE-624 Fig. 4 Ø22mm
DE-625 Fig. 5 Ø24mm

HANDLES FOR MOUTH MIRRORS

- Ручки для зеркал
- Manches pour miroirs à bouche
- Mundspiegelgriffe
- Ручки для дзеркал
- Mangos para espejos de boca
- مقابض لمرآيا الفم



DE-626
Hollow Mirror
Handle Round
Ø 10 mm



DE-627
Hollow Mirror
Hexagonal
Handle
Ø 8 mm



DE-628
Hollow
Ø 8 mm



DE-629
Hollow Mirror
Hexagonal
Handle
Ø 10 mm



DE-630
Hollow Mirror
Handle
Ø 8 mm



DE-631
Hollow Mirror
Handle
Ø 10 mm

BUSHIDO
INSTRUMENTS

Cone-Socket Mirror Handle



DE-632
Mirror Handle
Solid
Ø 6 mm



DE-633
Mirror Handle
Solid
Ø 6 mm



DE-634
Mirror Handle
Solid Octagonal
Ø 6 mm



DE-635
Mirror Handle
Stem
with Rule
35mm



DE-636
Mirror Handle
Solid
Stem with
Rule 35mm



DE-637
Cone-Socket
Solid Octagonal
Ø 6 mm



DE-638
Cone-socket
Solid
Ø 6 mm



DE-639
Cone-socket
Hexagonal
Handle
Ø 6 mm

EXPLORERS

- Зонды
 - Sondes
 - Zahnsonden
- Зонди
 - Sondas
 - المستكشفين

Examination kit Set of 3 Pieces



DE-640
Probe

DE-641
Mirror

DE-642
College Forcep
15cm



Examination Set of 4 Pieces



DE-643
Exp,23/17-A

DE-644
Exavators

DE-645
Tweezers

DE-646
Mouth Mirror

DE-647

First Aid Examination Set of 3 Pieces



DE-648

First Aid Examination Set of 3 Pieces



DE-649

First Aid Examination Set of 3 Pieces



DE-650

First Aid Examination Set of 3 Pieces



TWEEZERS

- Пинцеты
- Précelles - Brucelles
- Zahnpinzetten

- Пинцети
- Pinzas para algodón
- ملاقط



DE-651
Surgical
11.5cm



DE-652
London College
15cm



DE-653
Semken Taylor
Str.



DE-654
Semken Taylor
Cvd.



DE-655
Meriam
16cm



DE-656
Dressing
14cm



DE-657
Semken Taylor
1x2 Straight



DE-658
Semken Taylor
1x2 Curved



DE-659
Gilles
15cm 1x2



DE-660
14cm 1x2



DE-661
Perry
13cm



DE-662
Atraumatic
15cm Cvd



DE-663
Atraumatic
15cm Str.



DE-664
College with Lock
15cm Cvd.



DE-665
Gerald
17.5cm



DE-666
with lock
15cm



DE-667
Atraumatic
17.5cm

TWEEZERS

- Пинцеты
- Précelles - Brucelles
- Zahnpinzetten

- Пинцети
- Pinzas para algodón
- ملاقط



DE-668
Adson-TC
12cm



DE-669
Adson-TC
12cm 1x2



DE-670
Adson-TC
15cm 1x2



DE-671
Adson
12cm



DE-672
Adson
12cm 1x2



DE-673
Adson
15cm 1x2



DE-674
Adson Brown
12cm



DE-675
Crane Kaplan
15cm



DE-676
Crane Kaplan
15cm



DE-677
Crane Kaplan
15cm



DE-678
Hemingway
15cm



DE-679
Miller
15cm Str.



DE-680
Miller
15cm Cvd.



DE-681
Dressing
Tweezer
14.5cm



DE-682
College
Curved
Tip
15cm



DE-683
Maryam
Tweezers
15cm



DE-684
College
Tweezer
15cm



DE-685
Perry
Tweezer
12.5cm



DE-686
Self-locking
Tweezer
15cm

EXPLORERS

- Зонды
- Sondes
- Zahnsonden
- Зонди
- Sondas
- المستكشفين

Single Ended Probe Solid Handle 4.5mm Length 150mm



Explorers-Single-End

Double-Ended Explorers

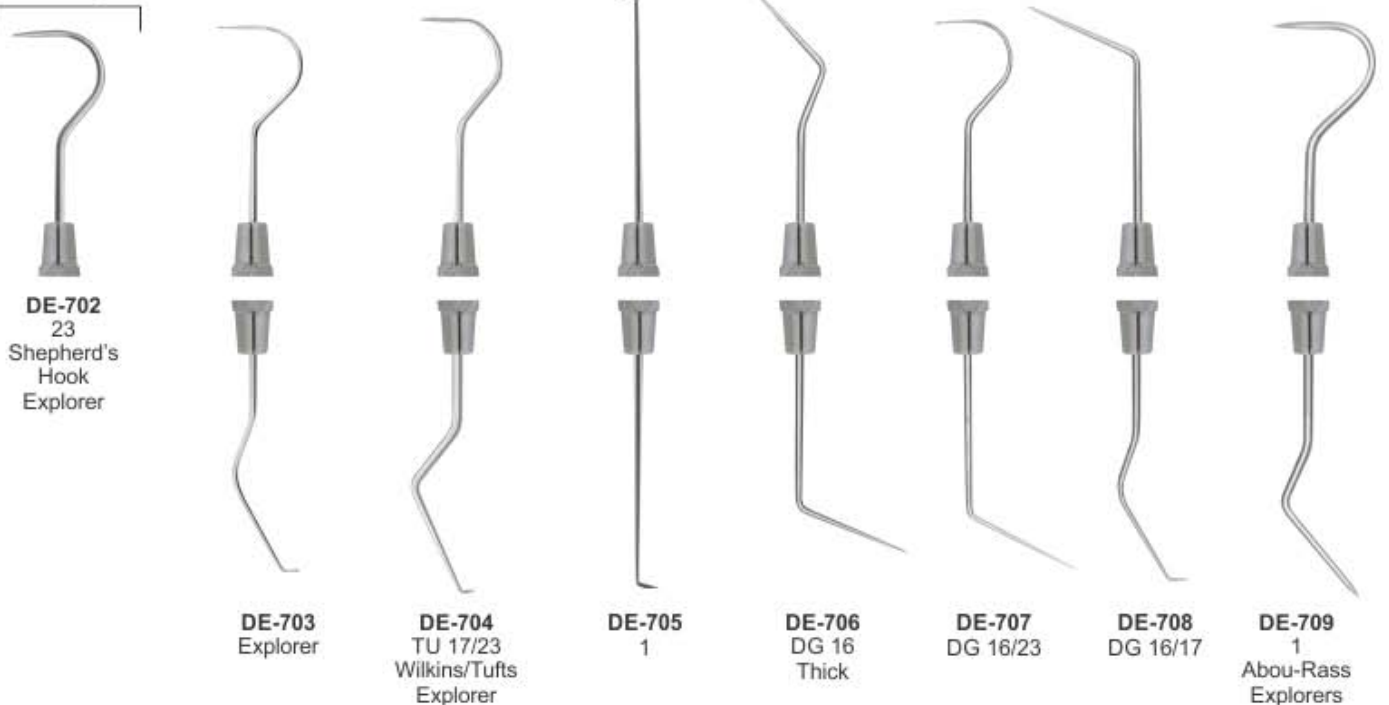

- Зонды
- Sondes
- Zahnsonden
- Зонди
- Sondas
- المستكشفين

Probes Double Ended 6mm, length 170mm

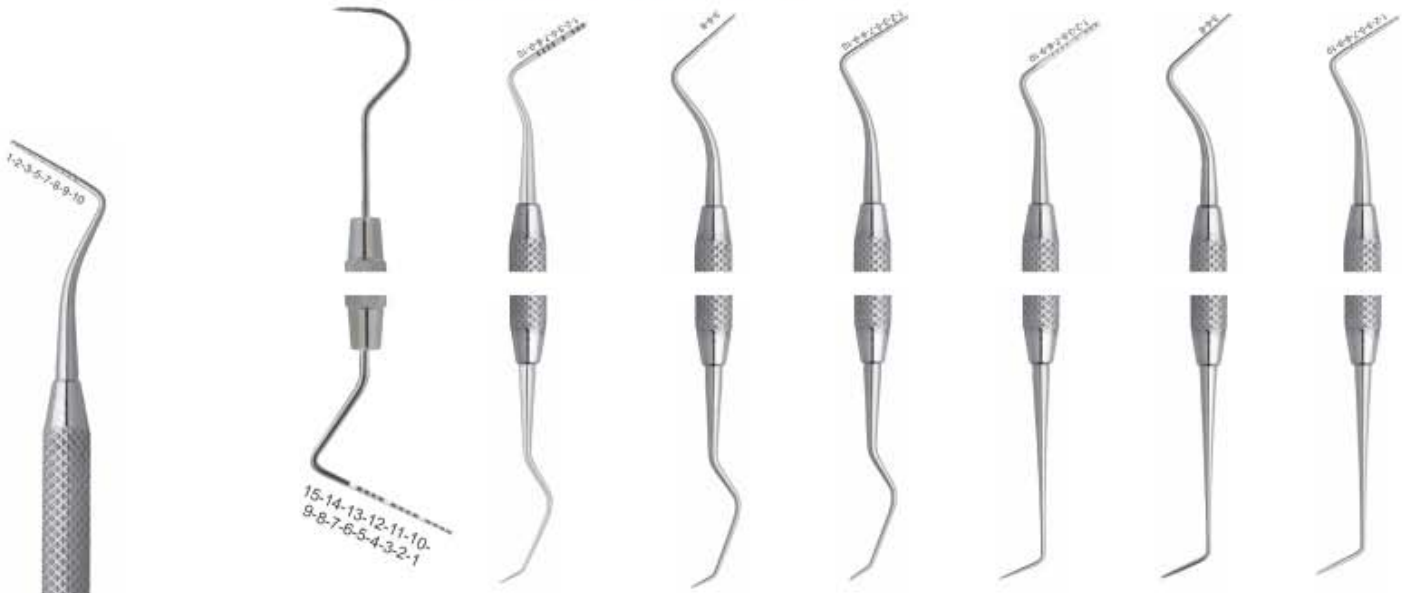

DE-711
23/UNC1
university of north carolina Explorer

DE-712
Goldman Fox
Fig.17

DE-713
University
of Michigan
Fig.17

DE-714
Williams
Fig.17

DE-715
Goldman Fox
Fig.16

DE-716
University
of Michigan
Fig.16

DE-717
Williams
Fig.16

Pointed Probes Double Ended Handle 6mm, length 170mm



DE-710
Williams

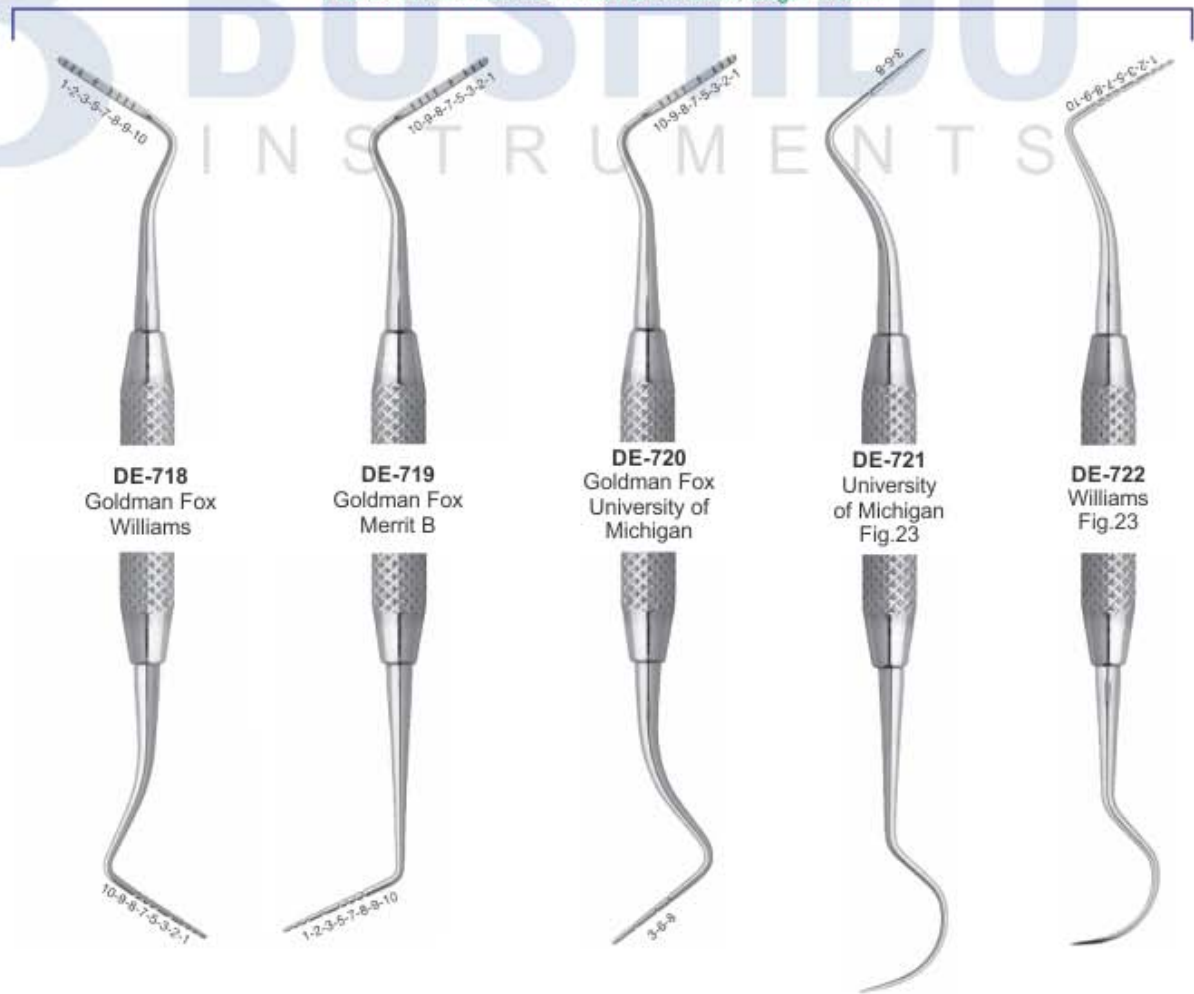

DE-718
Goldman Fox
Williams

DE-719
Goldman Fox
Merrit B

DE-720
Goldman Fox
University of
Michigan

DE-721
University
of Michigan
Fig.23

DE-722
Williams
Fig.23

EXPLORERS

- Зонды
- Sondes
- Zahnsonden
- Зонди
- Sondas
- المستكشفين

EXPLORERS INSTRUMENTS SOLID HANDLE 6MM, LENGTH 170MM

PLUGGERS

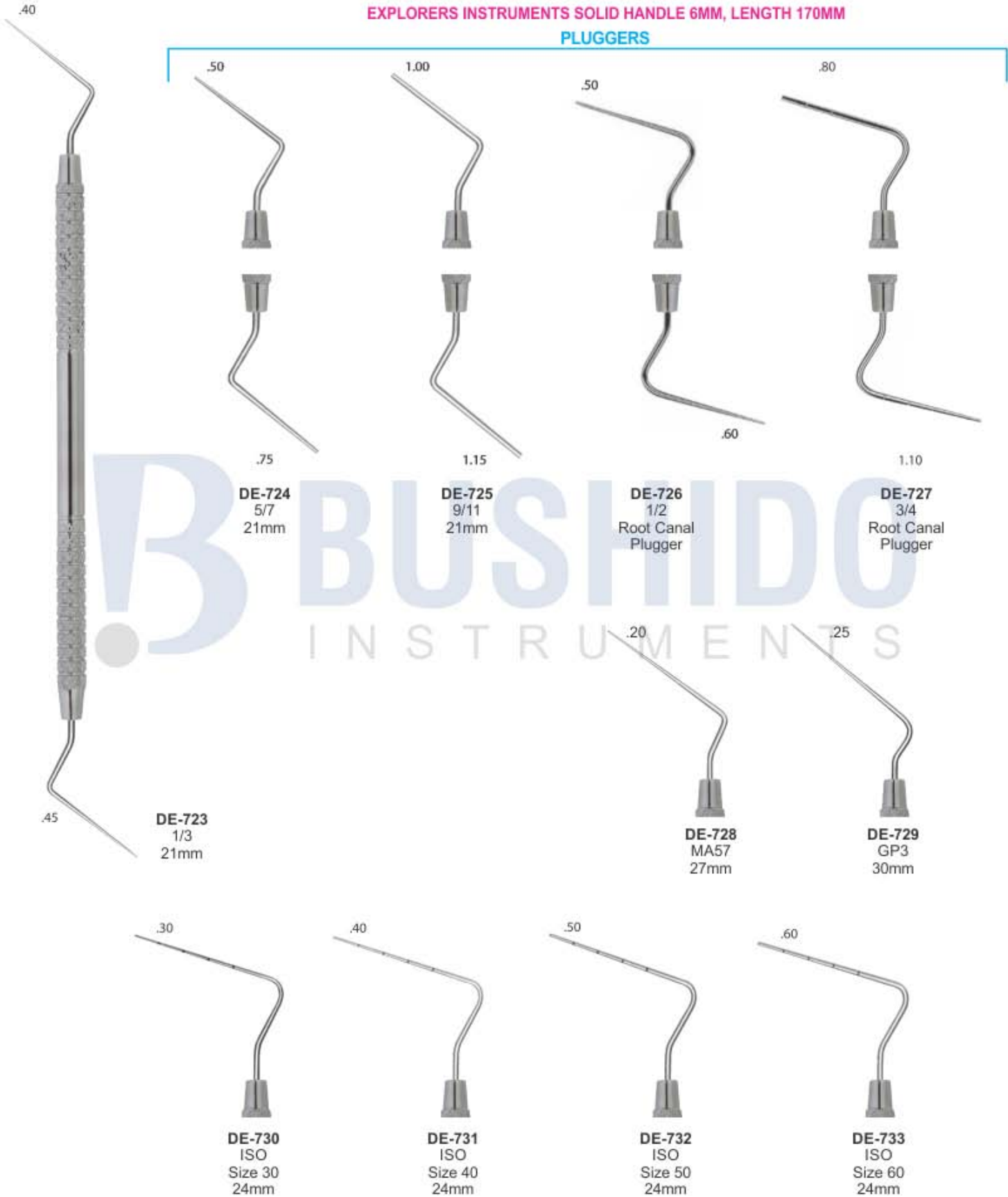

PERIODONTAL PROBES

- Зонды пародонтологические
- Sondes paradontales
- sonde parodontali

- зонди пародонтологічні
- Sondas paradontales
- المسابر اللثة

SPREADERS

HEAT CARRIERS

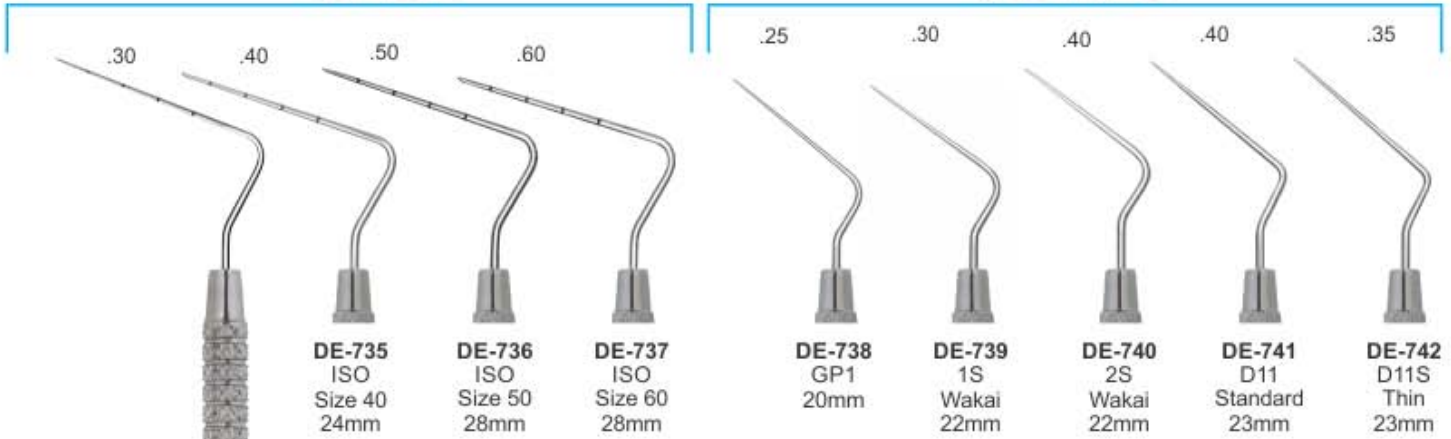

HEAT CARRIERS



PERIODONTAL PROBES

- Зонды пародонтологические
- Sondes paradontales
- sonda parodontali
- зонди пародонтологічні
- Sondas paradontales
- المسابير اللثة

ENDODONTICS INSTRUMENTS

ANTERIOR



LUKS





DE-762
Gracey Curettes 1/2



DE-763
Gracey Curettes 3/4



DE-764
Gracey Curettes 5/6



DE-765
Gracey Curettes 7/8



DE-766
Gracey Curettes 9/10



DE-767
Gracey Curettes 11/12



DE-768
Gracey Curettes 13/14



DE-769
Gracey Curettes 1/2



DE-770
Gracey Curettes 3/4



DE-771
Gracey Curettes 5/6



DE-772
Gracey Curettes 7/8



DE-773
Gracey Curettes 9/10



DE-774
Gracey Curettes 11/12



DE-775
Gracey Curettes 13/14



GRACEY MINI FIVE

Hollow Handle 9.5mm, Length 170mm Ceramic Coated Handle



DE-777
Fig. 3/4 Gracey 3M



DE-778
Fig. 5/6 Gracey 3M



DE-779
Fig. 7/8 Gracey 3M
Buccal and lingual/
Palatal surfaces



DE-780
Fig. 11/12 Gracey 3M
Mesial



DE-781
Fig. 13/14 Gracey 3M
Distal

DE-776
Fig. 1/2
Gracey 3m



GRACEY AFTER FIVE

Hollow Handle 9.5mm, Length 170mm Ceramic Coated Handle



DE-783
Gracey 3/4 AF



DE-784
Gracey 5/6 AF



DE-785
Gracey 7/8 AF



DE-786
Gracey 11/12 AF



DE-787
Gracey 13/14 AF

DE-782
Gracey
1/2 AF



Gracey Curettes



$\frac{3...1}{3...1}$	$\frac{1...3}{1...3}$	DE-788 Fig. 1/2 GR - Gracey Buccal surfaces
$\frac{3...1}{3...1}$	$\frac{1...3}{1...3}$	



$\frac{5...1}{5...1}$	$\frac{1...5}{1...5}$	DE-789 Fig. 3/4 GR - Gracey Lingual/Palatal surfaces
$\frac{5...1}{5...1}$	$\frac{1...5}{1...5}$	



$\frac{5...1}{5...1}$	$\frac{1...5}{1...5}$	DE-790 Fig. 5/6 GR - Gracey
$\frac{5...1}{5...1}$	$\frac{1...5}{1...5}$	



$\frac{8...4}{8...4}$	$\frac{4...8}{4...8}$	DE-791 Fig. 7/8 GR - Gracey Buccal and lingual/ palatal surfaces
$\frac{8...4}{8...4}$	$\frac{4...8}{4...8}$	



$\frac{8...4}{8...4}$	$\frac{4...8}{4...8}$	DE-792 Fig. 9/10 GR - Gracey Buccal and lingual/ palatal surfaces more angled
$\frac{8...4}{8...4}$	$\frac{4...8}{4...8}$	



$\frac{8...4}{8...4}$	$\frac{4...8}{4...8}$	DE-793 Fig. 11/12 GR - Gracey Mesial
$\frac{8...4}{8...4}$	$\frac{4...8}{4...8}$	



$\frac{8...4}{8...4}$	$\frac{4...8}{4...8}$	DE-794 Fig. 13/14 GR - Gracey Distal
$\frac{8...4}{8...4}$	$\frac{4...8}{4...8}$	



$\frac{8...4}{8...4}$	$\frac{4...8}{4...8}$	DE-795 Fig. 15/16 GR - Gracey Mesial
$\frac{8...4}{8...4}$	$\frac{4...8}{4...8}$	



$\frac{8...4}{8...4}$	$\frac{4...8}{4...8}$	DE-796 Fig. 17/18 GR - Gracey Distal
$\frac{8...4}{8...4}$	$\frac{4...8}{4...8}$	

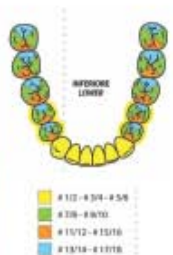
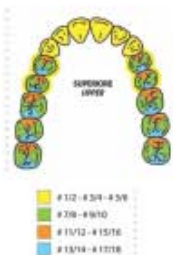

Sickle Scalars



DE-797 Fig. U15/33 - Towner-Jaquette



DE-798 Fig. U15/30 - Towner-Jaquette



DE-799 Fig. H5/33



DE-800 Fig. H6/H7



DE-801 Fig. 30/33 - Jaquette



DE-802 Fig. T2/T3 - Taylor



DE-803 Fig. 204



DE-804 Fig. 204S



DE-805 Fig. 11/12 - MC - McCall
Mesial



DE-806 Fig. 13/14 -
Distal

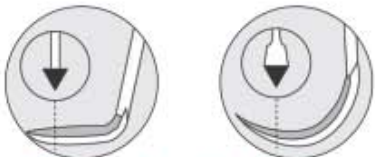

Straight and curved sickle scalars
Feature: 2 cutting edges curved facial component tipped ends



Universal curettes
are characterized by an angle of 90° between the terminal stem and the cutting component.



Gracey curettes
are characterized by an angle of 70° between the terminal stem and the cutting component.

Universal Curettes



DE-807 Fig. 13S/14S - MC - McCall



DE-808 Fig. 17S/18S - MC - McCall
Distal



DE-809 Fig. M23



DE-810 Fig. 204SD



DE-811 Fig. YG7/8-Younger Good



DE-812 Fig. L 1/2 - Langer



DE-813 Fig. L 3/4 - Langer



DE-814 Fig. L 5/6 - Langer



DE-815 Fig. M 23A



DE-816 Fig. M 23B

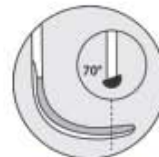
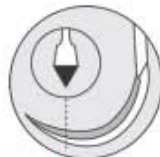
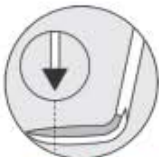

Straight and curved sickle scalers

Feature: 2 cutting edges curved facial component tipped ends

Universal curettes

are characterized by an angle of 90° between the terminal stem and the cutting component.

Gracey curettes

are characterized by an angle of 70° between the terminal stem and the cutting component.

Periodontal knives



DE-817
7

Goldmann-Fox

DE-818
8

Goldmann-Fox

DE-819
11

Goldmann-Fox

DE-820
2

Ebnetzer

DE-821
16K15

Kirkland

DE-822
1

Orban

DE-823
1

Guldener

DE-824
19
Mühlemann



0.9 MM



0.7 MM

Chisels
Diamond coated margin trimmers



Thanks to the diamond-coated hand instruments the margins are evenly levelled.

Margin trimmers



DE-835
1TH2 Hirt



DE-836
5TH6 Hirt



DE-837
3TH4 Hirt



DE-838
7TH8 Hirt



DE-839
62NS61

2.0 MM

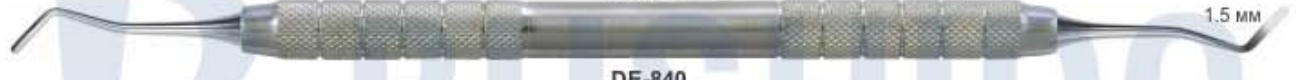

DE-840
37NS36

1.5 MM



DE-841
66NS65

1.0 MM



DE-842
79CI80 Black



DE-843
77CI78 Black



DE-844
279CI280 Black



DE-845
277CI278 Black



DE-846
179CI180 Black



DE-847
177CI178 Black

CHISELS



DE-848
1/2 Werdelstaedt



DE-849
3/4 Werdelstaedt



DE-850
7 Straight



DE-851
5/6 Straight



DE-852
7/10 Straight



DE-853
8/9 Binangle



DE-854
11/12 Binangle



DE-855
40/41 Binangle

Tartar Remover Instruments Solid Handle Ø 6 mm



DE-856
Fig. 1



DE-857
Fig. 1L
Left



DE-858
Fig. 1R
Right



DE-859
Fig. 2L
left



DE-860
Fig. 2R
Right



DE-861



DE-862



DE-863



DE-864
WHITE 28



DE-865
WHITE 29



DE-866
WHITE 31



DE-867
WHITE 32



DE-868
WHITE 33



DE-869
WHITE 34



DE-870
WESTCOTT 21



DE-871
WESTCOTT 21B



DE-872



DE-873



DE-874
WHITE



DE-875
WHITE



DE-876



DE-877



DE-878



DE-879



DE-880



DE-881



DE-882



DE-883



DE-884



DE-885
PLANATOR



DE-886
PLANATOR



Ball Burnishers



DE-895



DE-896



DE-897



DE-898



Hatches



DE-899



DE-900



DE-901
Mini-Spatel



DE-902
Mini-Spatel

Spatulas rounded and sharp

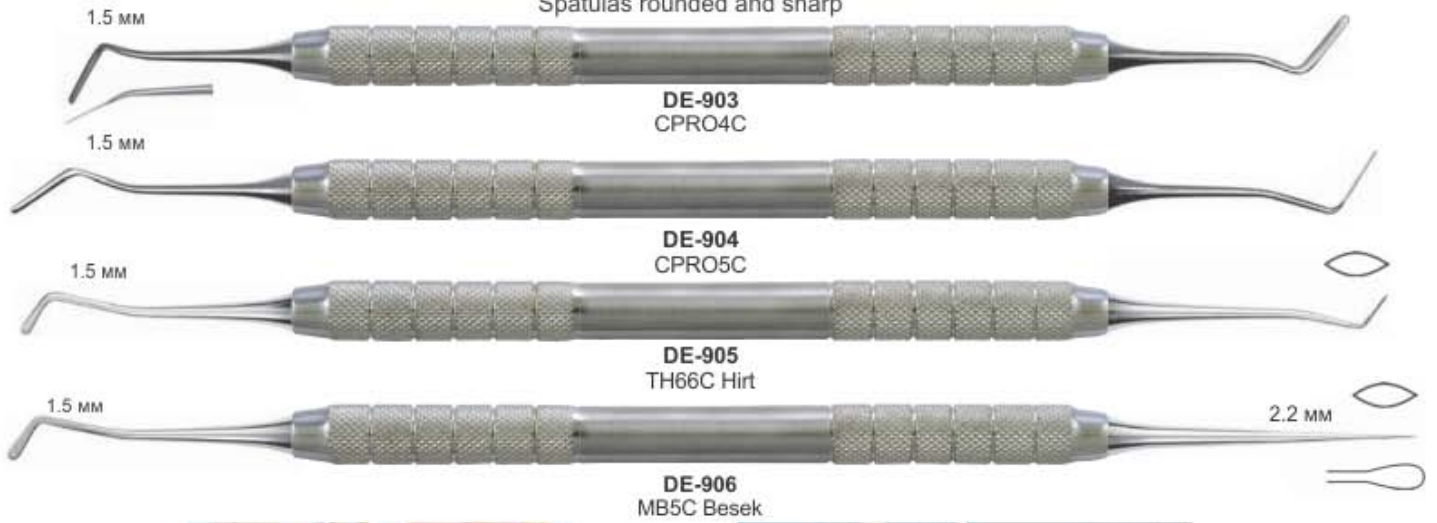

Spatulas Blade Thickness 0.22 mm



Spatulas

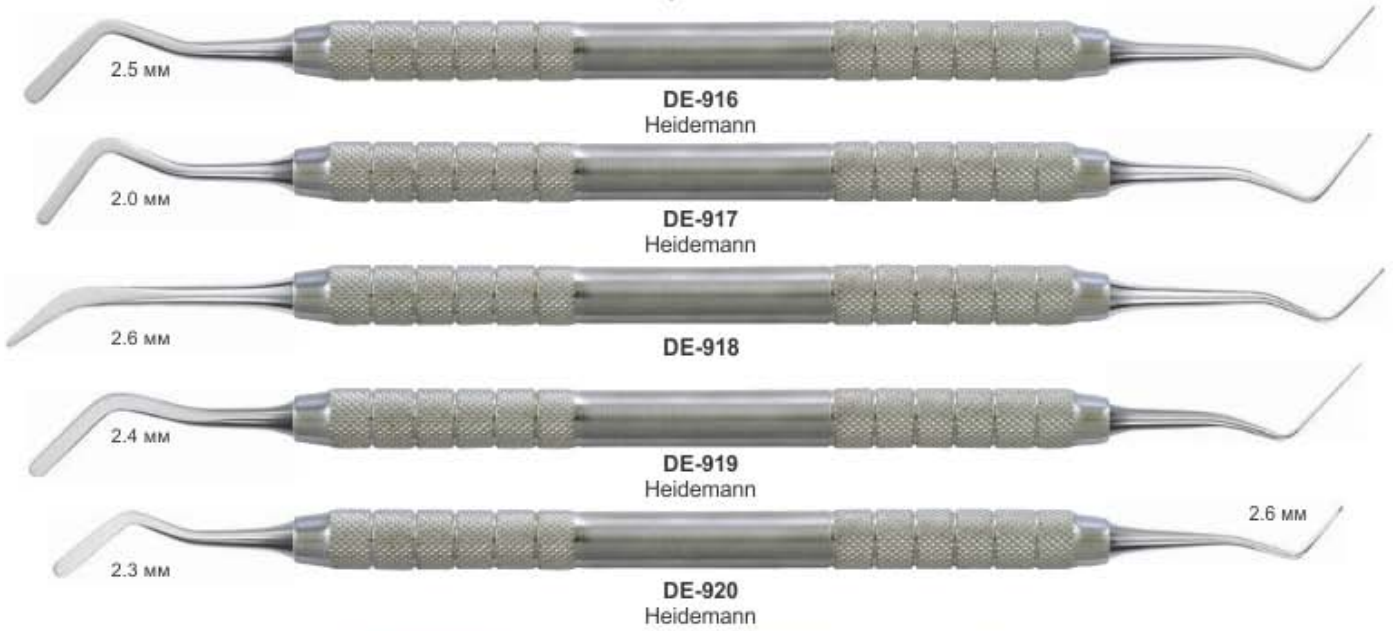

Spatulas-Pluggers



Water drop Our excavators have particularly sharp blades, free of burrs and perfectly rounded.





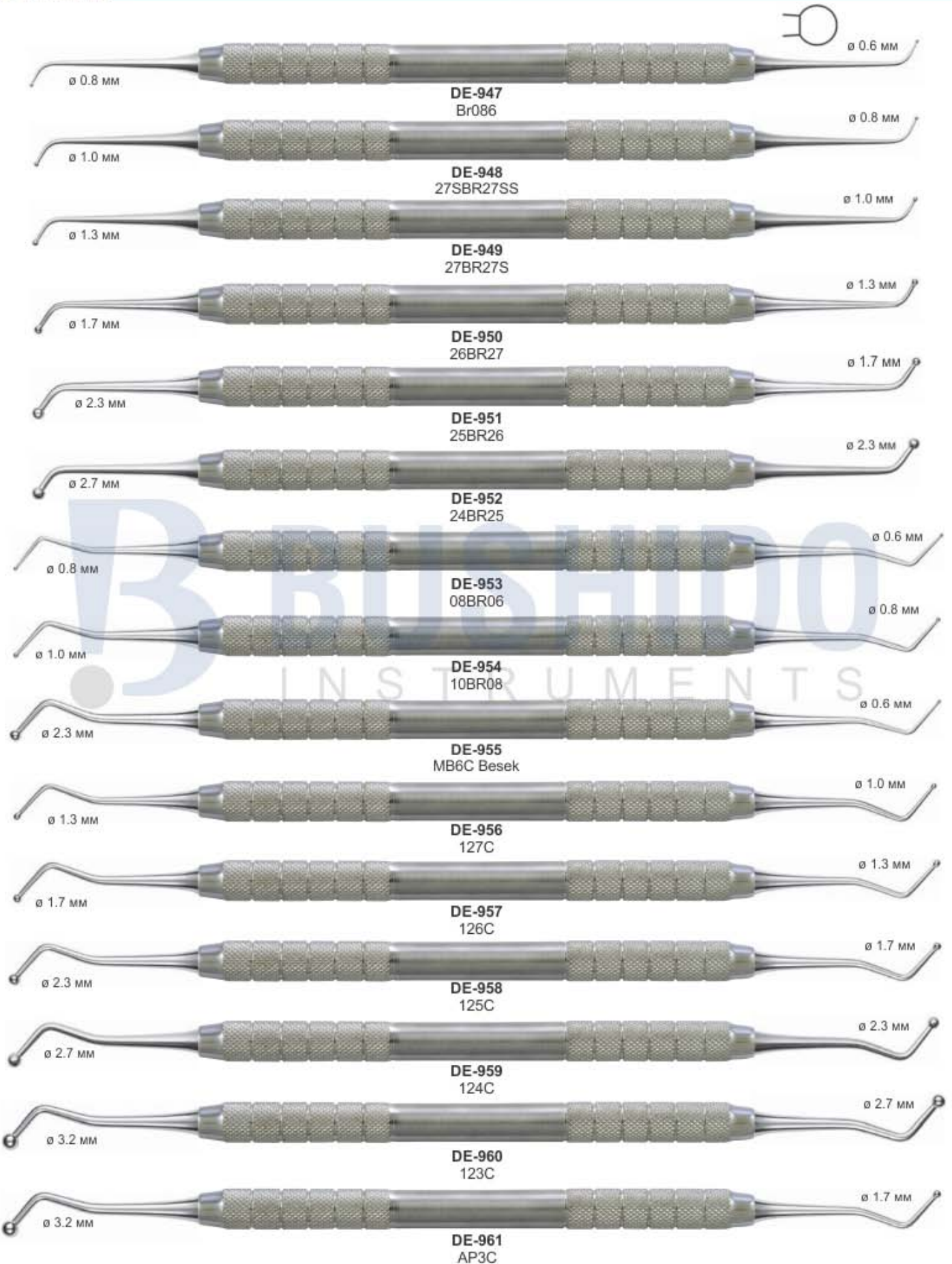











DE-1005
WILLIAMS



DE-1006
WILLIAMS



DE-1007
WILLIAMS



DE-1008



DE-1009



DE-1010



DE-1011



DE-1012



DE-1013



DE-1014

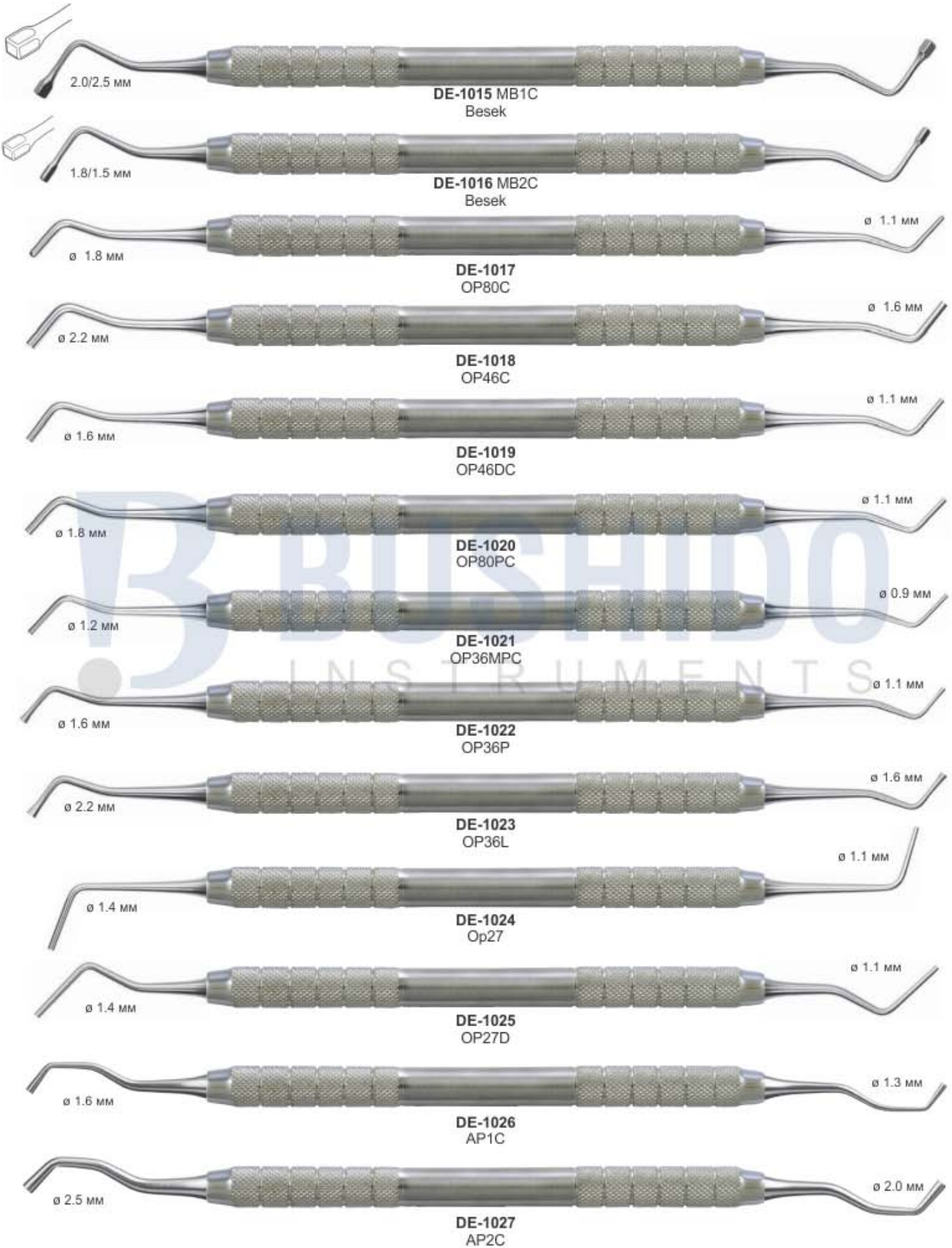



Serrated Pluggers





DE-1042 MF2C
Fuzzi



DE-1043
Pj4



DE-1044 MB3C
Besek



DE-1045
HZ3C



DE-1046
CPRO3C

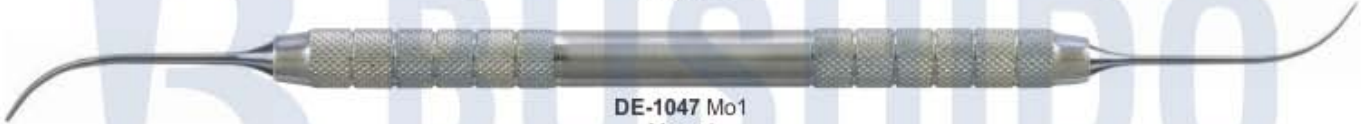

DE-1047 Mo1
Monari



DE-1048 TH28C
Hirt



DE-1049
HZ25C



DE-1050
Ck10



DE-1051
CK28BC



DE-1052 Op37
Carver



DE-1053
28BR29

Round excavators**Cariology**

- for the removal of softened, carious dentin
- for the removal of temporary fillings

Surgery

- to sever the periodontal ligament prior to extraction
- for the removal of granulation tissue after extraction

Design: Round working end Curved cutting edge



Round Excavator, 1.0 mm
DE-1054



Round Excavator, 1.5 mm
DE-1055



Round Excavator, 2.0 mm
DE-1056

Triple-angled back action excavators

Triple-angled Back Action Excavator, 1.0 mm
DE-1057

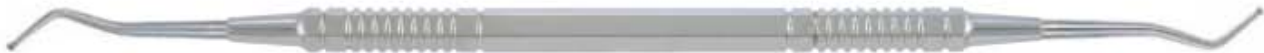

Triple-angled Back Action Excavator, 1.5 mm
DE-1058



Triple-angled Back Action Excavator, 2.0 mm
DE-1059



Triple-angled Back Action Excavator, 3.5 mm
DE-1060

FILLING INSTRUMENTS

- Инструменты для реставрации
- Instruments pour plombage
- Füllungsinstrumente (mit Kontrawinkel)
- Инструменти для реставрації
- Instrumentos para obturaciones
- ملء الصكوك

COMPOSITE/PLASTIC FILLING INSTRUMENTS SOLID HANDLE 6MM, LENGTH 170MM

BLACK

PLUGGERS/CONDENSERS

Hollenback

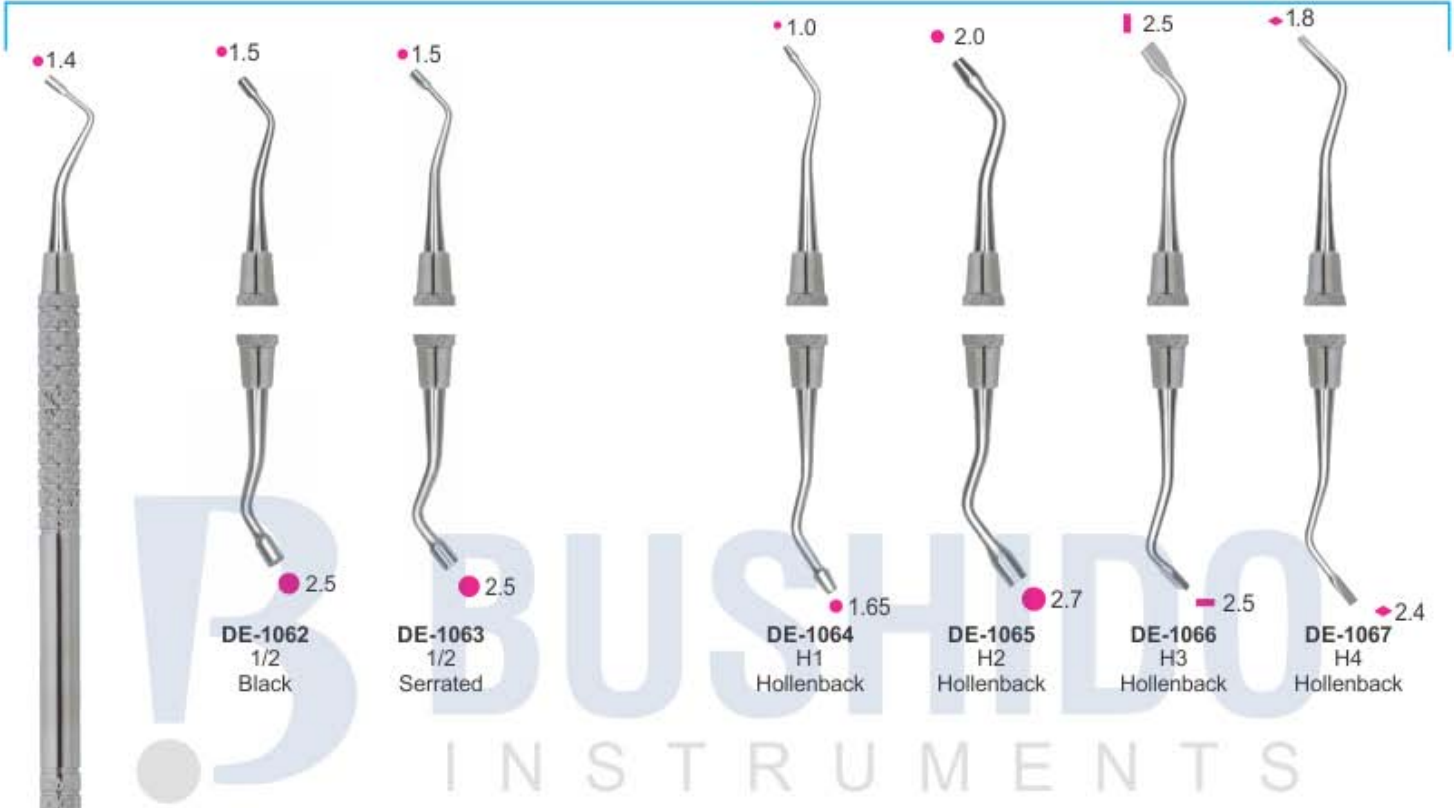

MARQUETTE CONDENSER

MORTONSON

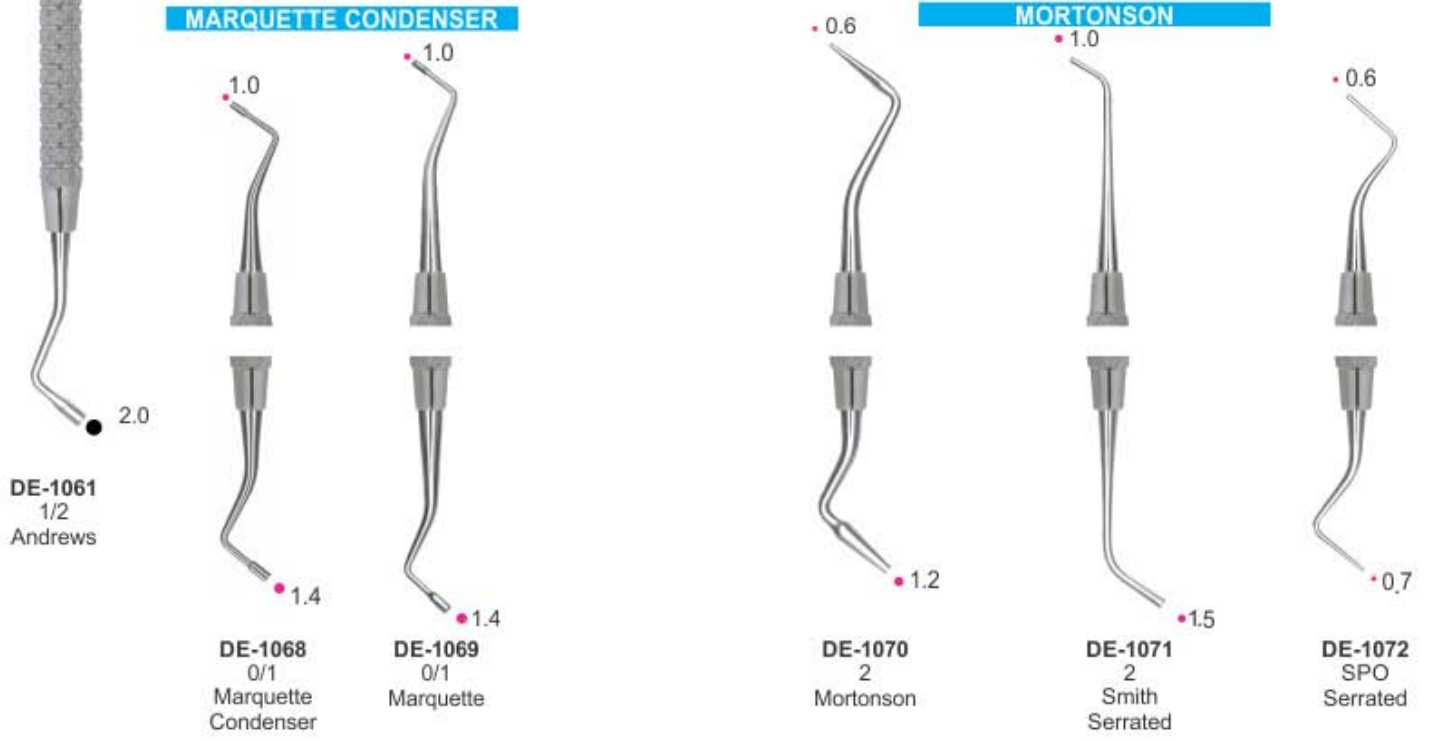

FILLING INSTRUMENTS

- Инструменты для реставрации
- Instruments pour plombage
- Füllungsinstrumente (mit Kontrawinkel)
- Инструменти для реставрації
- Instrumentos para obturaciones
- ملء الصكوك

RESTORATIVE INSTRUMENTS SOLID HANDLE 6MM, LENGTH 170MM Back Action Filling Instruments

Tanner Filling Instruments

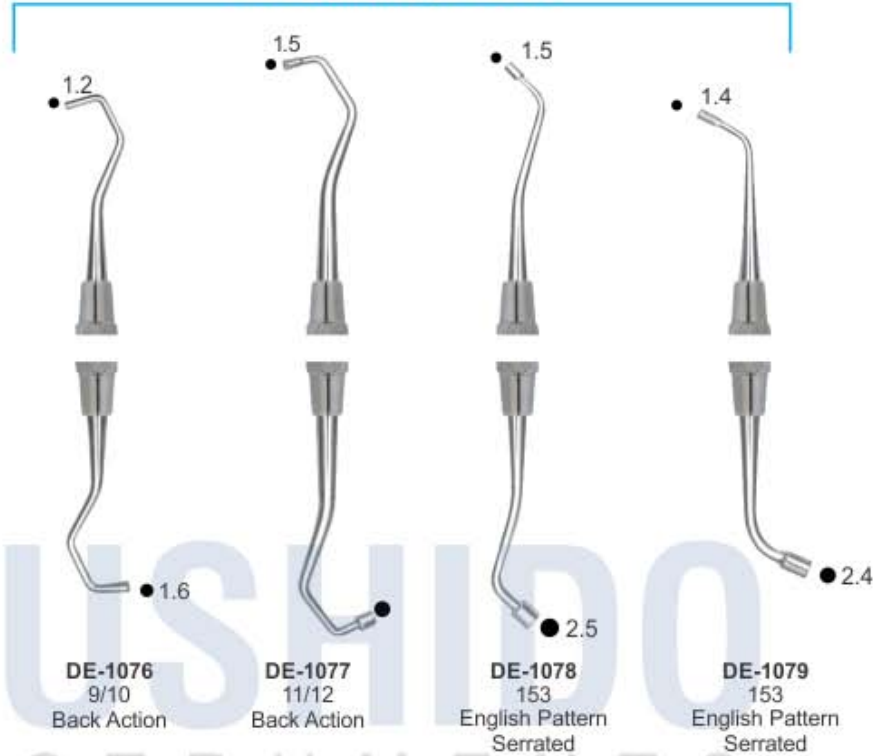
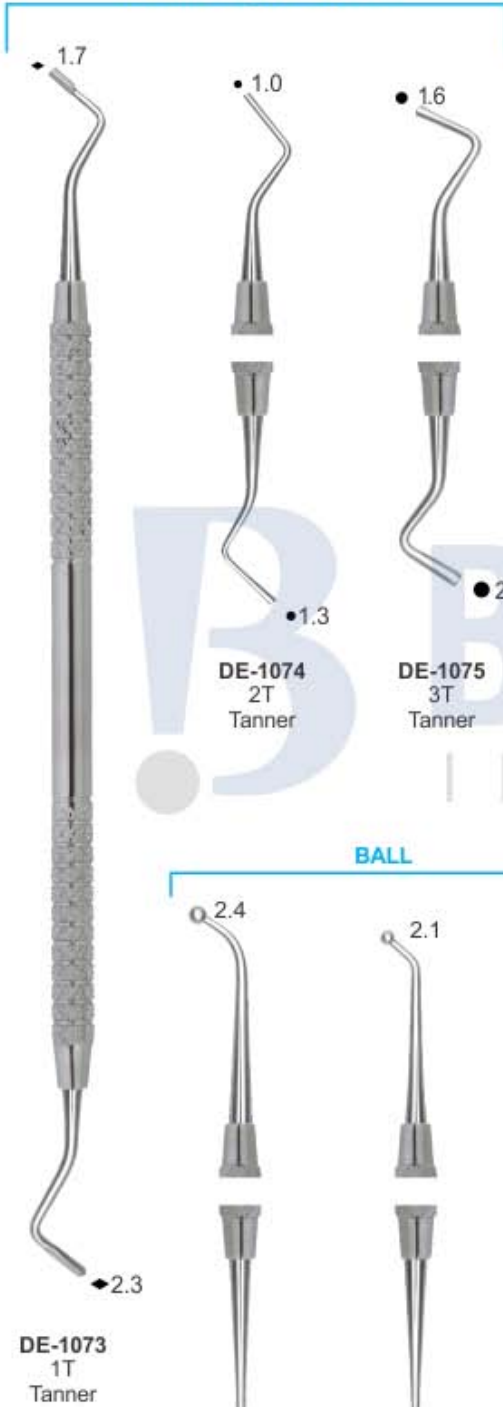

BALL

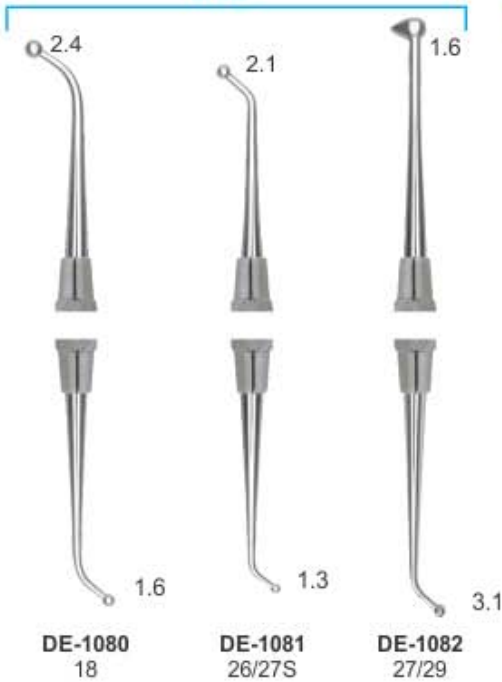

BURNISHERS

BEAVERTAIL



ACORN



LADMORE



CARVERS INSTRUMENTS

- Инструменты для реставрации
- Instruments a modeler
- Modellierinstrumente

- Инструменти для реставрації
- Instrumentos para modelar
- ادوات تطعيم

P.K. THOMS WAXING INSTRUMENTS SOLID HANDLE 6mm



DE-1095
Composite Instruments Blue
Titanium with Cassettes



DE-1094
P.k. Thomas Waxing Instruments Kit

COMPOSITE INSTRUMENTS TITANIUM BLUE ENDODONTIC

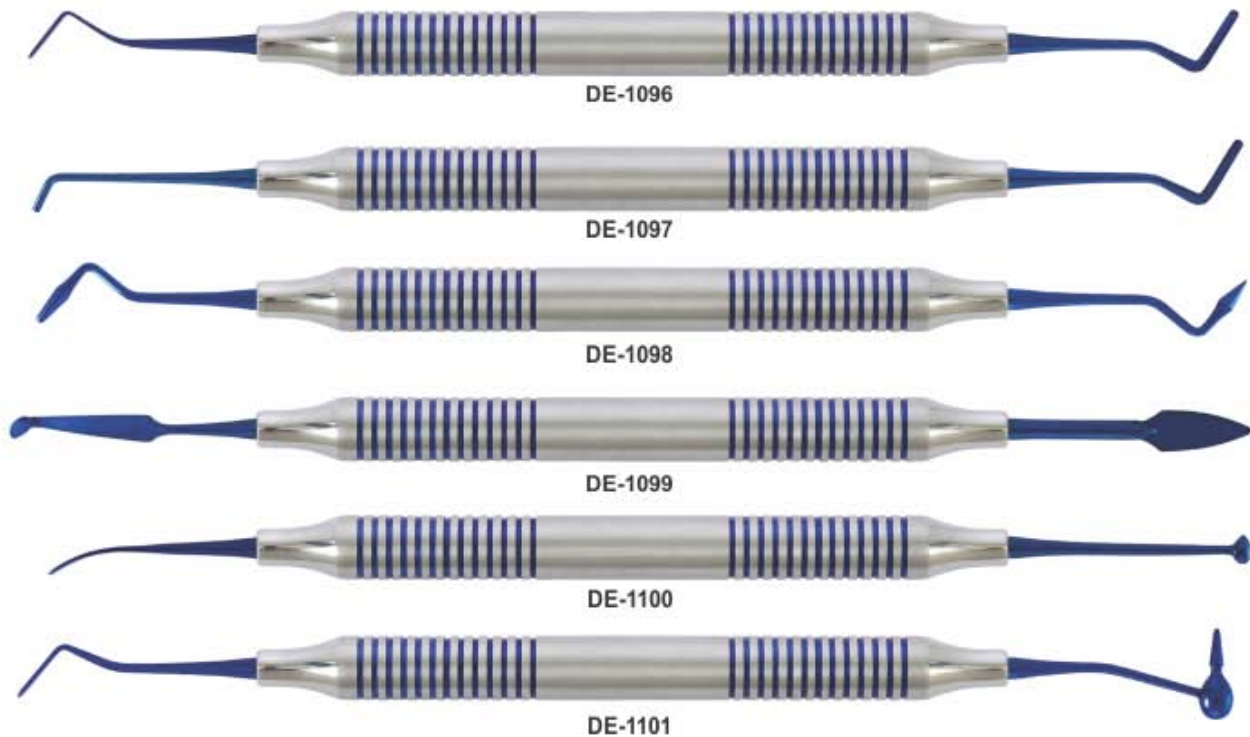

CARVERS INSTRUMENTS

- Инструменты для реставрации
- Instruments a modeler
- Modellierinstrumente
- Инструменти для реставрації
- Instrumentos para modelar
- أدوات تقطيع



DE-1102



DE-1103



DE-1104



DE-1105



DE-1106



Cassette For 5 Instruments
DE-1107

FILLING INSTRUMENTS

- Инструменты для реставрации
- Instruments pour plombage
- Füllungsinstrumente (mit Kontrawinkel)
- Инструменти для реставрації
- Instrumentos para obturaciones
- ملء الصكوك

FILLING INSTRUMENTS (Gold Pointed) SOLID HANDLE 6MM, LENGTH 170MM



COMPOSITE FILLING INSTRUMENTS

- Инструменты для реставрации
- Instruments pour plombage
- Füllungsinstrumente (mit Kontrawinkel)
- Инструменти для реставрації
- Instrumentos para obturaciones
- ملء الصكوك

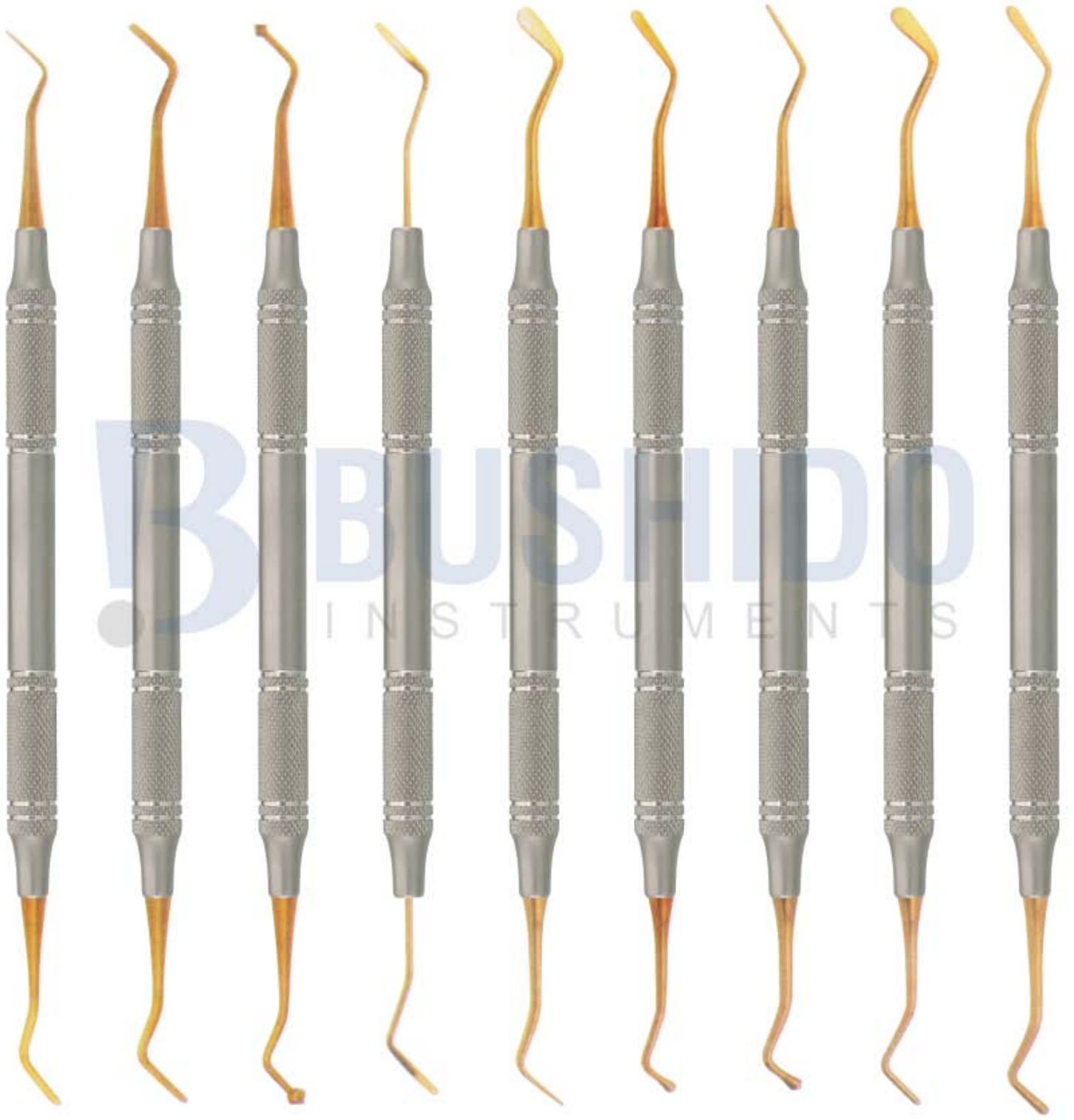

DE-1118

DE-1119

DE-1120

DE-1121

DE-1122

DE-1123

DE-1124

DE-1125

DE-1126

- Инструменты для реставрации
- Instruments pour plombage
- Füllungsinstrumente (mit Kontrawinkel)

- Инструменти для реставрації
- Instrumentos para obturaciones
- ملء الصكوك

Composite Gold Tip Instruments



- Прочие товары
- Divers produits et services
- Sonstige Produkte
- Інші товари
- Varios Productos
- المنتجات المتنوعة



DE-1138
X Ray Film Hangers



DE-1139
X Ray Film Hangers



DE-1140
X Ray Film Hangers



DE-1141
X Ray Film Hangers



DE-1142
X Ray Film Hangers



DE-1143
X Ray Film Hangers



DE-1144
X Ray Film Hangers



DE-1145



DE-1146



DE-1147



Dissecting Set
DE-1148 Set of 9 Pcs.
DE-1149 Set of 11 Pcs.



DE-1150
Napkin Holder with Plastic Chain

DE-1151
Napkin holder with metal chain



Mouth Props
DE-1152
Small

Mouth Props
DE-1153
Medium

Mouth Props
DE-1154
Large

Key Rings



DE-1155



DE-1156



DE-1157



DE-1158



DE-1159



DE-1160

CEMENT SPATULAS

- Шпатели для цемента
- Spatules à ciment
- Zementspatel

- Шпателі для цементу
- Espátulas para cemento
- ملاعق الأسمنت



WAX KNIVES

- Ножи для воска
 - Couteaux a cire
 - Wachsmesser
- Ножи для воску
 - Cuchillos para cera
 - المسكين الشمع

ALGINATE, PLASTER SPATULAS, WAX KNIVES PLASTER FOR KNIVES & PLASTER SHEAR



DE-1183 Wooden Handle Fig. 5 21.5 cm	DE-1184 Wooden Handle Fig. 7 19.5 cm curved	DE-1185 Wooden Handle Fig. 8 20 cm curved	DE-1186 Wooden Handle Fig. 9 22.5 cm curved	DE-1187 Hook Knives	DE-1188 Fig. 1 Lessmann 12.5 cm	DE-1189 Fig. 2 Lessmann 17 cm	DE-1190 Fig. 1 with small spoon 12.5 cm	DE-1191 Fig. 2 with large spoon 17 cm
--	---	---	---	-------------------------------	---	---	---	---



DE-1192 Bacolite Handle Wax Knives, Small	DE-1193 Bacolite Handle Wax Knives, Large	DE-1194 Wooden Handle Wax Knives, Small	DE-1195 Wooden Handle Wax Knives, Large	DE-1196 Plaster Knife	DE-1197 Fig. 1 17 cm	DE-1198 Fig. 3 16 cm	DE-1199 Fig. 4 16 cm	DE-1200 Special Inox 19.5 cm
---	---	---	---	---------------------------------	-----------------------------------	-----------------------------------	-----------------------------------	---

ARTICULATORS

- Артикуляторы
- Artocilar
- Artikulations

- Артикулятори
- Articuler
- ارتیکو لاتورس



DE-1201

Technical Datas:

Intercondylar distance	120 mm.
condylar inclination	fixed at 30°
Bennet angle	fixed at 7°
Incisal table inclination	10°
Distance between mounting plates	85 mm.
Weight	400 gr.
Opening (item 5000)	125°
Opening (item 5010)	180°



DE-1202

Technical Datas:

Intercondylar distance	110 mm.
condylar inclination	fixed at 30°
Bennet angle	fixed at 7°
Incisal table inclination	flat
Distance between mounting plates	85 mm.
Weight	450 gr.
Opening	180°



DE-1203

Stainless Steel Finishing

DE-1204

Royal Blue



DE-1205



DE-1206



DE-1207



DE-1208



DE-1209



DE-1210



DE-1211



DE-1212



DE-1213



DE-1214
Nakawalni
Dental Laboratory
Instrument

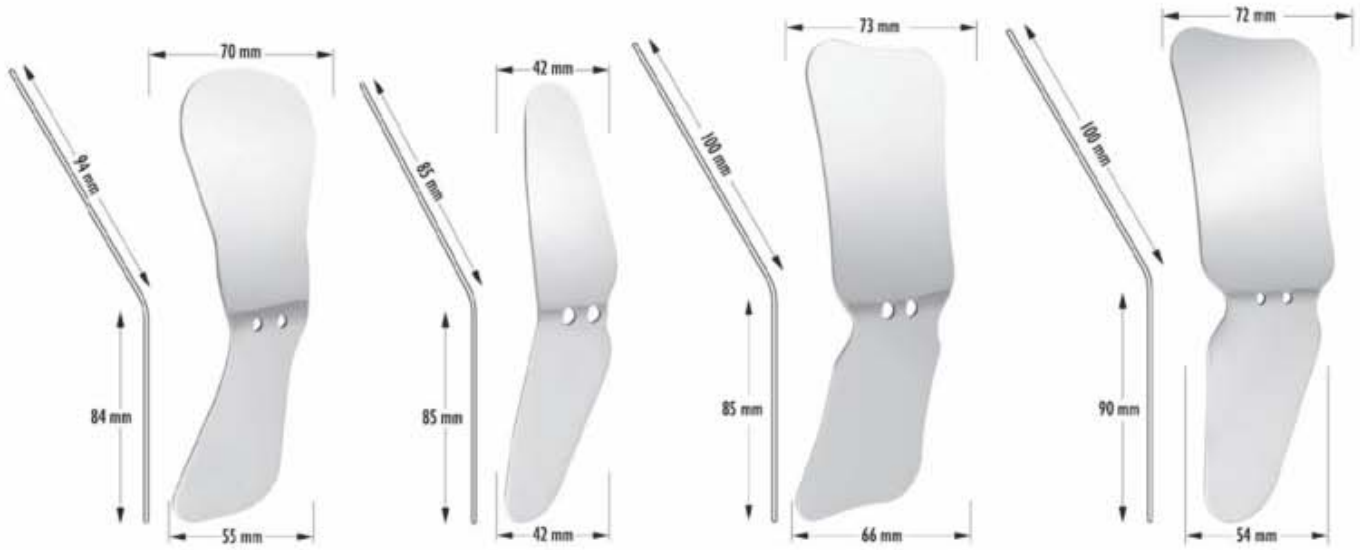

DE-1215 Adult Palatal /
DE-1216 Child Palatal

DE-1217
Buccal

DE-1218 Adult Palatal /
DE-1219 Child Palatal

DE-1220 Adult Palatal /
DE-1221 Adult Buccal

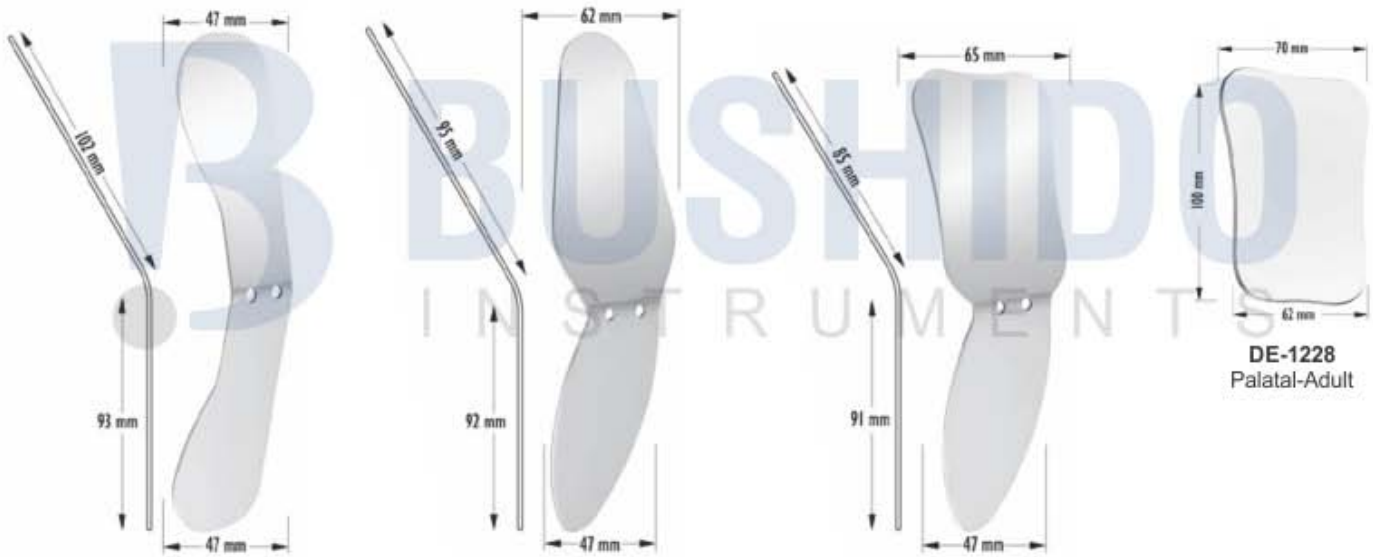

DE-1222 Lingual upper /
DE-1223 Lingual Lower

DE-1224 Adult Buccal /
DE-1225 Child Buccal

DE-1226 Child Palatal /
DE-1227 Child Buccal

DE-1228
Palatal-Adult

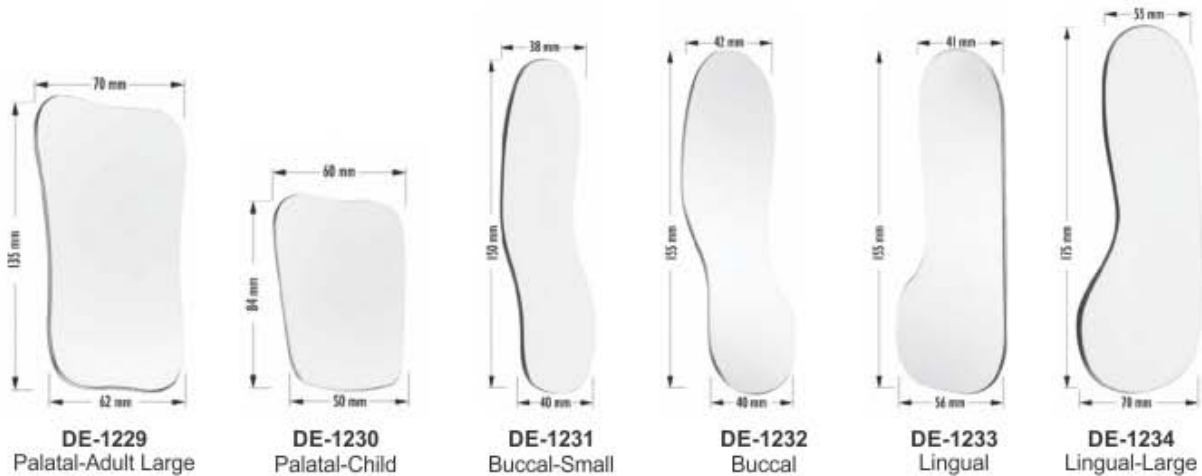

DE-1229
Palatal-Adult Large

DE-1230
Palatal-Child

DE-1231
Buccal-Small

DE-1232
Buccal

DE-1233
Lingual

DE-1234
Lingual-Large