

BONE SURGERY INSTRUMENTS

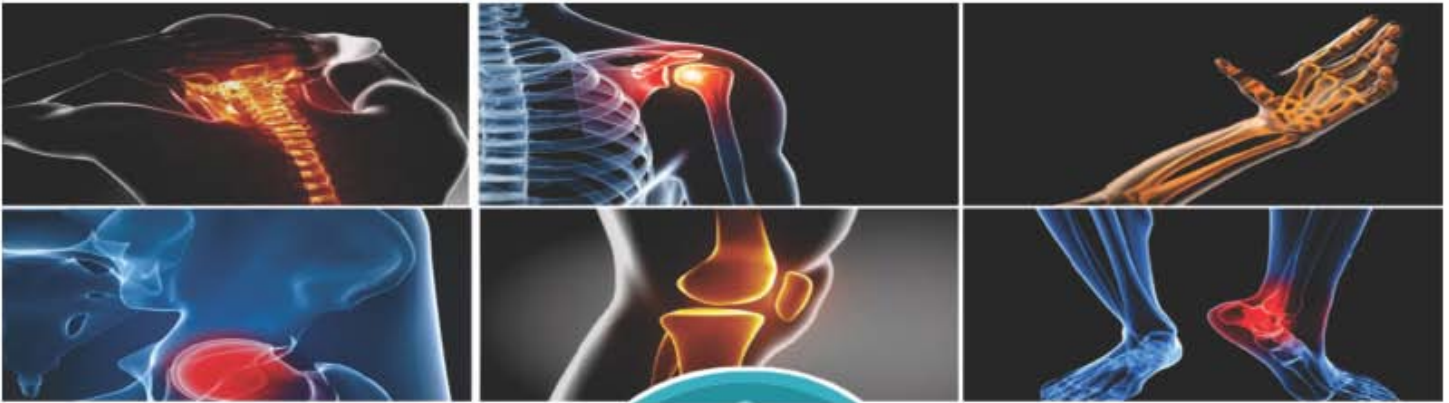

amputations-und resektionssagen | sierra para amputacion y reseccion
Scies a amputation et resection | seghe per amputazione



Satterlee Saw
10-001 29cm
Stainless Steel Ring Handle
Straight tip, Straight shaft



Charriere Bone Saw
10-002 27cm
10-003 30cm
10-004 34cm
Straight tip, Straight shaft



Charriere Saw
10-005 35cm
Spare saw blades
10-006 12mm
10-007 15mm



Charriere Bone Saw Complete
10-008 35.5cm
Straight tip,
Straight shaft



Helferich-Bier Saw
10-009 39cm
Spare saw blades
10-010 3mm
10-011 5mm
10-012 5mm



Charriere Saw
10-013 25 cm
10-014 27 cm
Double saw



Engel Plaster Saw
10-015 15.5 cm



Serra Gigli
10-016 30 cm
10-017 40 cm
10-018 50 cm



Percy Amputation Shield
10-019 30.5cm
Handles Detachable,
Simple Pattern



Putti Bone Rasp
10-020 27cm
Double ended,
One end curved up
one end curved sideways



Putti Rasp
10-021 30cm
Double Ended



Putti Bone File
10-022 28cm
semicircular



Putti Bone File
Bayonet Shape
10-023 24.5cm
X=13 mm
semicircular



Putti Bone File
10-024 22cm
X=20 mm
flat



Joseph Bone Saw / Rasp
10-025 19cm
Single Sided



Linderman Amputation Saw
10-026 19cm
20cm Blade



Wellenschliff Nasal Saw
10-027 19cm
Straight



Langenbeck Metacarpal Saw
10-028 23cm
11.5cm Blade

Knochenfeilen

Limes à os

Limas para huesos

Lime per ossa



Patella Bone Saw
10-029 Includes 1 blade
10-030 Replacement blade only
Delrin Handle



Foman Rasp
10-031 21.5cm
Double ended, Fine & coarse serrations 4-sided convex and flat blades



Foman Rasp
10-032 21cm

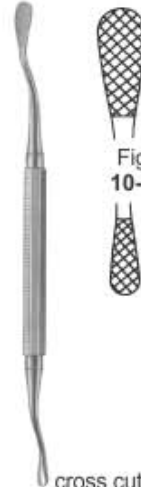

Miller-Colburn Bone File
18 cm



Fig. 1
10-033

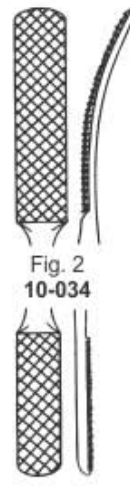

Fig. 2
10-034

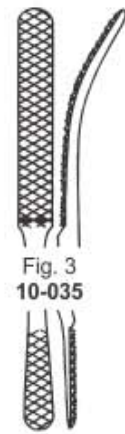

Fig. 3
10-035



Fig. 4
10-036

cross cut



Kleinert-Kutz Bone Rasp
10-037 22.5cm
Double ended,
Fine & course serrations



Miller Alveotomy File
10-038 19cm



Miller Alveotomy File
10-039 19cm



Gallaher Bone Rasp
10-040 18cm
10-041 25cm
Curved



Gallaher Bone Rasp
10-042 18cm
10-043 25cm
Convex Curve



Gallaher Bone Rasp
10-044 18cm
10-045 25cm
Straight



Good Bone File / Rasp
10-046 16.5cm
Straight



Kistler Ear Cartilage Rasp
10-047 left
10-048 right
16.5cm Curved



Micro Rasp
10-049 14cm
Single ended
double sided



Nail Rasp
10-050 17cm
Single sided



Maltz Rasp
10-051 18cm
Single-Ended
Single sided



Improved Maltz Rasp
10-052 18cm
Single-Ended,
up & down rasping



Putti Rasp
10-053 23cm
falt / flat
10-054 30.5cm
Round / flat

Raspeln, Feilen
Rapes, Limes

Escofinas, limas
Raspe, lime



Miller Rasp
10-055 21.5cm
Double Ended straight
single Sided



Fomon Rasp
10-056 21.5cm
Double Ended straight
single Sided
one side concave



Fomon Rasp
10-057 21.5cm
Double Ended straight
single Sided
one side convex



Fomon Rasp
10-058 21.5cm
Double Ended straight
single Sided



Fomon Rasp
10-059 21.5cm
Double Ended straight
single Sided
one side concave



Fomon Rasp
10-060 21.5cm
Double Ended straight
single Sided
one side convex



Chisel Blade Handle
10-061 18.5cm



Chisel blades,
interchangeable
10-062 8.5cm
5mm
10-063 8.5cm
10mm
10-064 8.5cm
16mm
10-065 8.5cm
25mm



Osteotome blades,
interchangeable
10-066 8.5cm
5mm
10-067 8.5cm
10mm
10-068 8.5cm
16mm
10-069 8.5cm
25mm

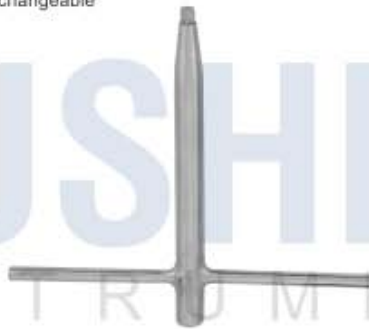

Chisel Blade key
10-070 9cm



Osteotome
13.5cm
10-071 8mm
10-072 10mm
10-073 12mm
10-074 14mm
10-075 16mm



Chisel
13.5cm
10-076 8mm
10-077 10mm
10-078 12mm
10-079 14mm
10-080 16mm



Gouge
13.5cm
10-081 8mm
10-082 10mm
10-083 12mm
10-084 14mm
10-085 16mm



Lucas Chisel
16cm
10-086 3mm
10-087 4mm
10-088 5mm
10-089 6mm



Lucas Gouge
16cm
10-090 3mm
10-091 4mm
10-092 5mm
10-093 6mm



**U.S. Army Pattern
Chisel**
16.5 cm
10-094 6 mm wide
10-095 12 mm wide
10-096 18 mm wide



Parsch Chisel	Parsch Chisel	Parsch Chisel
11.5cm	13.5cm	17.5cm
10-097 2mm	10-103 2mm	10-109 2mm
10-098 3mm	10-104 3mm	10-110 3mm
10-099 4mm	10-105 4mm	10-111 4mm
10-100 6mm	10-106 6mm	10-112 6mm
10-101 7mm	10-107 7mm	10-113 7mm
10-102 8mm	10-108 8mm	10-114 8mm

Knochenmeißel
Ciseaux-burins, gouges

Cineles, gubias
Scalpelli, sgorbi



Partsch Gouge	Partsch Gouge	Partsch Gouge
11.5cm	13.5cm	17.5cm
10-115 2mm	10-121 2mm	10-127 2mm
10-116 3mm	10-122 3mm	10-128 3mm
10-117 4mm	10-123 4mm	10-129 4mm
10-118 6mm	10-124 6mm	10-130 6mm
10-119 7mm	10-125 7mm	10-131 7mm
10-120 8mm	10-126 8mm	10-132 8mm



Alexander Chisel
18cm

10-133 4mm
10-134 6mm
10-135 8mm
10-136 10mm
10-137 12mm
10-138 14mm



Alexander Gouge
18cm

10-139 4mm
10-140 6mm
10-141 8mm
10-142 10mm
10-143 12mm
10-144 14mm



Smith Peterson Gouge
20cm Straight

10-145 09 mm
10-146 14 mm
10-147 19 mm
10-148 25 mm

Curved

10-149 09 mm
10-150 14 mm
10-151 19 mm
10-152 25 mm



Straight

10-153 06 mm
10-154 09 mm
10-155 13 mm
10-156 16 mm
10-157 19 mm
10-158 25 mm
10-159 32 mm

Curved

10-160 06 mm
10-161 09 mm
10-162 13 mm
10-163 16 mm
10-164 19 mm
10-165 25 mm
10-166 32 mm

Smith Peterson Osteotome
20 cm



Straight

10-167 10 mm
10-168 15 mm
10-169 20 mm
10-170 25 mm

Curved

10-171 10 mm
10-172 15 mm
10-173 20 mm
10-174 25 mm

Stille Gouge
20 cm



Stille
20 cm



Stille Chisel
20 cm



Chisels

10-175 10 mm
10-176 12 mm
10-177 15 mm
10-178 20 mm
10-179 25 mm

Osteotome

10-180 10 mm
10-181 12 mm
10-182 15 mm
10-183 20 mm
10-184 25 mm



Stille Osteotome
20 cm

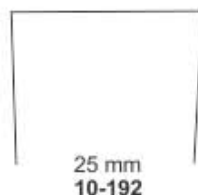

Lexer Osteotome
22 cm

10-193 7 mm
10-194 10 mm
10-195 12 mm
10-196 15 mm
10-197 20 mm
10-198 25 mm
10-199 30 mm

Lexer Modif. Osteotome
29 cm

10-200 7 mm
10-201 10 mm
10-202 12 mm
10-203 15 mm
10-204 20 mm
10-205 25 mm
10-206 30 mm



Lexer Modif. Chisel
29 cm

10-207 7 mm
10-208 10 mm
10-209 12 mm
10-210 15 mm
10-211 20 mm
10-212 25 mm
10-213 30 mm

Lexer Chisel
22 cm

10-214 7 mm
10-215 10 mm
10-216 12 mm
10-217 15 mm
10-218 20 mm
10-219 25 mm
10-220 30 mm



Lexer Gouge
25 cm

10-221 7 mm
10-222 10 mm
10-223 15 mm

Straight

Knochenmeißel

Cineles, gubias

Ciseaux-burins, gouges

Scalpelli, sgorbi



Lexer Gouge
25 cm
10-224 7 mm
10-225 10 mm
10-226 15 mm
Curved



Lexer Osteotome Flat
22 cm
10-227 10 mm
10-228 15 mm
10-229 20 mm
10-230 25 mm



Lexer Gouge Tuffnel Handle
22 cm
10-231 10 mm
10-232 15 mm
10-233 20 mm
10-234 25 mm



Mini Lexer Osteotome
10-235
18 cm



Mini Lexer Chisel
10-236
18 cm



Capener Osteotome With Tuffnel Handle
25cm
10-237 10mm
10-238 12mm
10-239 15mm
10-240 20mm
10-241 25mm
10-242 30mm
Straight



Capener Osteotome With Tuffnel Handle
25cm
10-243 10mm
10-244 12mm
10-245 15mm
10-246 20mm
10-247 25mm
10-248 30mm
Curved



Capener Chisels With Tuffnel Handle
25cm
10-249 6mm
10-250 8mm
10-251 10mm
10-252 12mm
10-253 15mm
10-254 20mm
10-255 25mm
10-256 30mm
Straight



Capener Osteotome With Tuffnel Handle
25cm
10-257 6mm
10-258 8mm
10-259 10mm
10-260 12mm
10-261 15mm
10-262 20mm
10-263 25mm
10-264 30mm
Curved



Raspatories
10-265 20cm
Medium straight blade
round edge, width 14mm



Raspatories
10-266 20cm
Large straight blade
round edge, width 20mm



Raspatories
10-267 20cm
Medium curved blade
round edge, width 14mm



Raspatories
10-268 20cm
Large curved blade
round edge, width 20mm



Mini Lexer Osteotome
10-269 20cm
18mm



Raspatories
10-270
28cm



Raspatories
10-271
28cm



Chisel
10-272
115mm/280mm
for extraction of cement

Knochenmeißel

Cineles, gubias

Ciseaux-burins, gouges

Scalpelli, sgorbi



Chisel
10-273
for extraction
of cement 9mm
Positive 400mm



Chisel
10-274
with 2 prong



**Lambotte
Osteotome**
25cm
10-275 6mm
10-276 8mm
10-277 10mm
10-278 13mm
10-279 15mm
10-280 20mm
10-281 25mm
10-282 30mm
10-283 38mm
10-284 44mm
10-285 50mm
Straight



**Lambotte
Osteotome**
25cm
10-286 6mm
10-287 8mm
10-288 10mm
10-289 13mm
10-290 15mm
10-291 20mm
10-292 25mm
10-293 30mm
10-294 38mm
10-295 44mm
10-296 50mm
Curved



**Mini-Lambotte
Osteotome**
12.5cm
10-297 3mm
10-298 4mm
10-299 6mm
10-300 8mm
10-301 10mm
10-302 12mm
10-303 15mm
Straight



**Mini-Lambotte
Osteotome**
17cm
10-304 3mm
10-305 4mm
10-306 6mm
10-307 8mm
10-308 10mm
10-309 12mm
10-310 15mm
Straight



Lambotte Osteotome
12.5cm, Straight
10-311 2mm tip width
10-312 4mm tip width
10-313 6mm tip width
10-314 8mm tip width
10-315 10mm tip width
10-316 12mm tip width
10-317 15mm tip width



Hex Handle Osteotome
15cm, Straight
10-318 2mm tip width
10-319 3mm tip width
10-320 4mm tip width
10-321 5mm tip width
10-322 6mm tip width
10-323 7mm tip width
10-324 9mm tip width
10-325 10mm tip width



Cottle Osteotome
18.5cm, Straight
10-326 4mm tip width
10-327 6mm tip width
10-328 9mm tip width
10-329 12mm tip width



**Anderson-Nievert
Osteotome**
20.4cm
10-330 Curved right
10-331 Curved left
10-332 Straight



Freer Gouge
10-333 15cm
06mm



Freer Chisel
10-334 16cm
04mm



**Shoulder
Penetrating Gouge**
10-335 21.6cm
Straight, 3mm distal tip



**Ballenger
Chisel** 16cm
10-336
4mm
10-337
6mm
10-338
8mm



**Mannerfelt
Modif.**



Osteotomes
10-339 4mm
10-340 6mm
10-341 8mm
15.5cm



Gouge
10-342
4mm
15.5cm



**Kilian,
Septum Gouge**
10-343 16cm
5mm



**Kilian-Claus
Septum Gouge**
10-344 16cm
5mm

Knochenmeißel

Cineles, gubias

Ciseaux-burins, gouges

Scalpelli, sgorbi



Stille
20cm



Stille Chisel
10-345 10mm
10-346 15mm
10-347 20mm
10-348 25mm
Straight



Stille Osteotome
10-349 10mm
10-350 15mm
10-351 20mm
10-352 25mm
Straight



Stille Osteotome
10-353 10mm
10-354 15mm
10-355 20mm
10-356 25mm
Curved



Stille Gouge
10-357 10mm
10-358 15mm
10-359 20mm
10-360 25mm
Straight



Stille Gouge
10-361 10mm
10-362 15mm
10-363 20mm
10-364 25mm
Curved



Smith-Petersen
20cm 8"



Smith-Petersen osteotome
10-365 6mm
10-366 9mm
10-367 13mm
10-368 16mm
10-369 19mm
10-370 25mm
10-371 32mm
Straight



Smith-Petersen Osteotome
10-372 6mm
10-373 9mm
10-374 13mm
10-375 16mm
10-376 19mm
10-377 25mm
10-378 32mm
Curved



Smith-Petersen Gouge
10-379 9mm
10-380 16mm
10-381 19mm
10-382 25mm
Straight



Smith-Petersen Gouge
10-383 9mm
10-384 16mm
10-385 19mm
10-386 25mm
Curved



Hoke Osteotome
14cm
10-387 3mm
10-388 5mm
10-389 7mm
10-390 8.5mm
10-391 10mm
10-392 12mm



Hibbs
24cm



Hibbs Osteotome
10-393 6mm
10-394 13mm
10-395 19mm
10-396 25mm
10-397 32mm
Straight



Hibbs Chisel
10-398 6mm
10-399 13mm
10-400 19mm
10-401 25mm
10-402 32mm
Straight



Hibbs Osteotome
10-403 6mm
10-404 13mm
10-405 19mm
10-406 25mm
10-407 32mm
Curved



Hibbs Gouge
10-408 6mm
10-409 13mm
10-410 19mm
10-411 25mm
10-412 32mm
Straight



Hibbs Gouge
10-413 6mm
10-414 13mm
10-415 19mm
10-416 25mm
10-417 32mm
Curved

Knochenmeißel
Ciseaux-burins, gouges

Cineles, gubias
Scalpelli, sgorbi

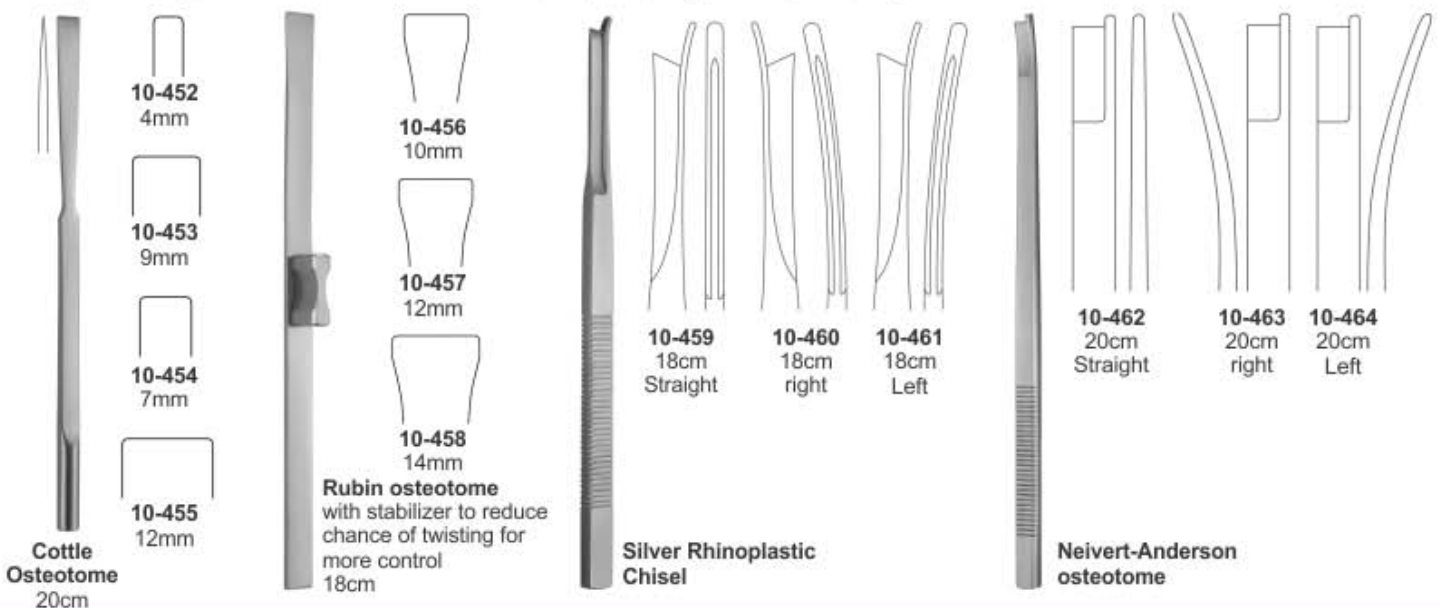
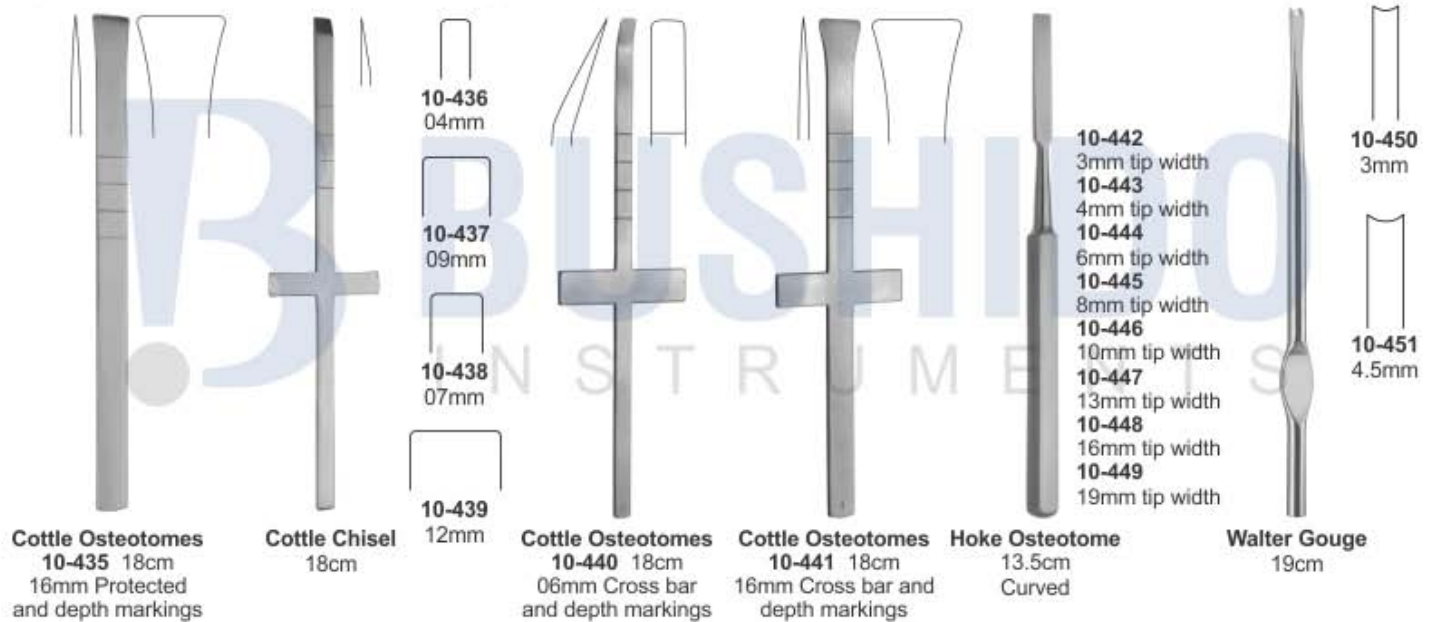
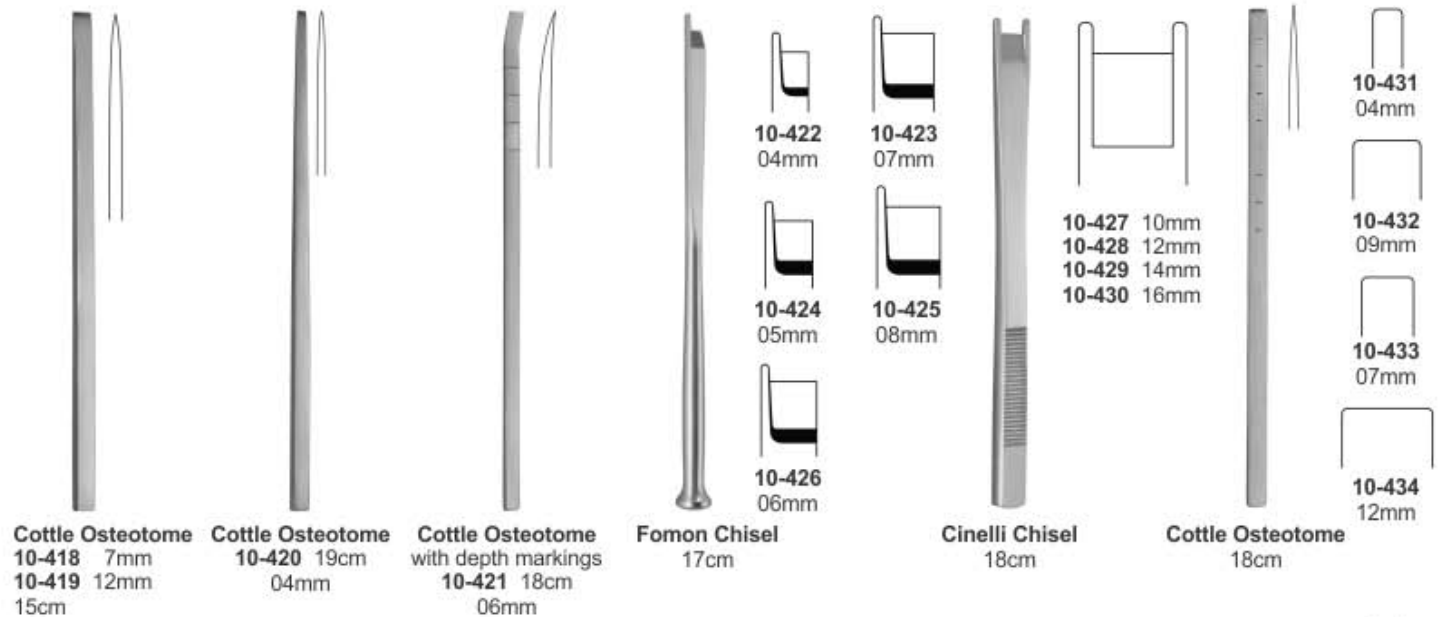

Meißel zur Nasenplastik

Osteotomes, ciseaux-burins pour rhinoplastique

Cinceles para rinoplastica

Scalpelli per plastica nasale

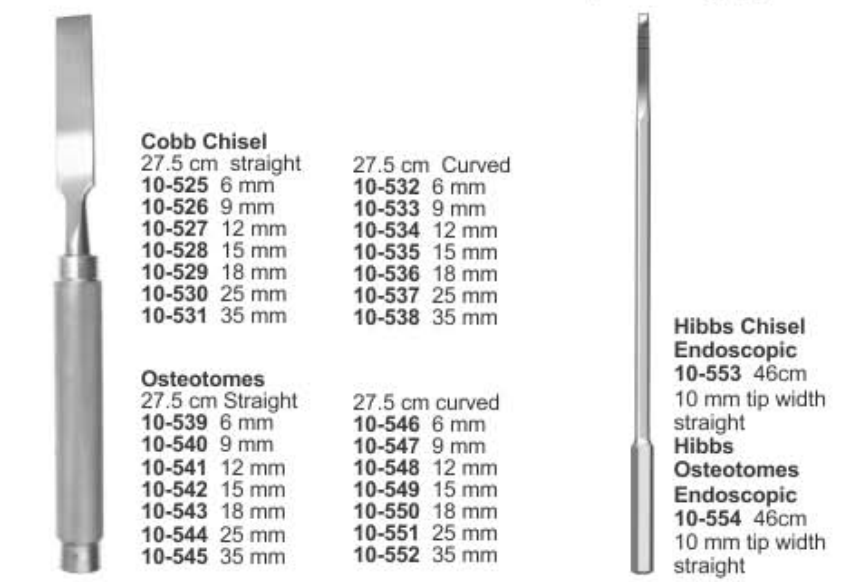
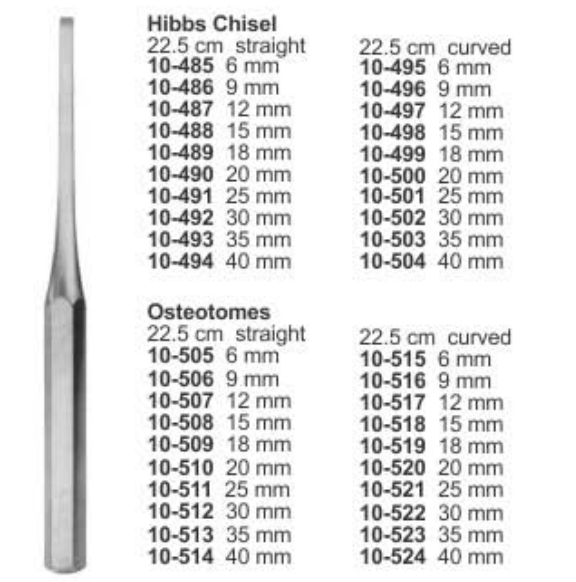
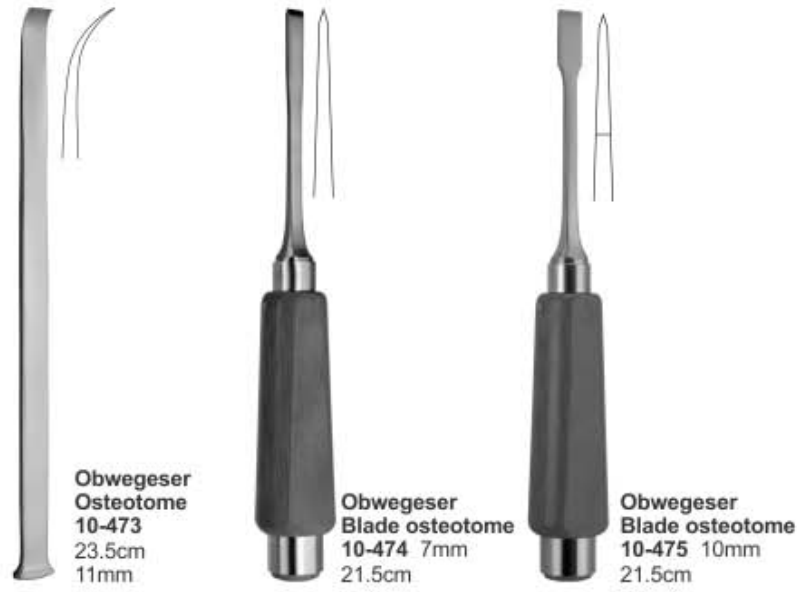
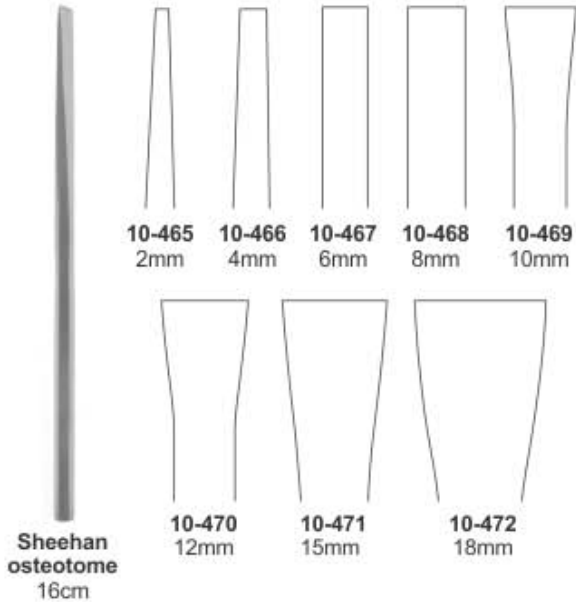

Hibbs Chisel / Osteotomes

Cobb Chisel / Osteotomes

Hammer | Martillos
Maillets | Martelli



Doyen Mallets
25cm
10-555
25mmØ - 120g
10-556
30mmØ - 180g
10-557
35mmØ - 260g



Collin Mallets
10-558
20cm
30mmØ - 220g



Hajek Mallets
10-559
21.5cm
27mmØ - 140g



Kirk Mallets
10-560 19cm
38mmØ - 750g
10-561 20.4cm
Head diameter
38.0mm,
Weight: 1 lb. 4 oz.
570 grams



Partsch Mallets
10-562 18cm
22mmØ - 200g



Lucae Mallets
10-563
19mmØ - 220g
10-564
25mmØ - 260g
19cm



Mallet Mallets
10-565 19cm
250mmØ - 205g
Solid steel, with
plastic faces



Cottle Mallets
10-566
18.5cm
30mmØ - 240g
1 side flat /
1 side convex



Williger Hammer
10-567 250g
10-568 350g



Neufield Hammer
10-569



**Solid Copper
Head Mallet**
10-570 16.5cm
Solid, Head
diameter
20mm



Nylon Head Mallet
10-571 19cm
Head diameter 25.4mm,
7.76 oz.
10-572 19.5cm
Head diameter 3cm
Weight 11 oz.



**Extra 3cm Nylon Face
FOR 10-572**
10-573 Head diameter
3cm



Combination Mallet
10-574 19.5cm
Solid, Head
diameter 32.0mm,
Weight 12 oz 340
grams, Head weight:
8 oz 227 grams



**Bergmann
Mallets**
10-575
24.5cm
45mmØ - 300g

Hammer	Martillos
Maillets	Martelli



Ombredanne Mallets
10-576
24cm
40mmØ - 550g



Heath Mallets
10-577 18cm
40mmØ - 700g
10-578 20cm
45mmØ - 1000g



Williger Mallets
10-579
28mmØ - 340g
10-580
30mmØ - 400g
24cm
Lead filled



Hajek Hammer
10-581 250gm
10-582 500gm



Universal Hammer
10-583 500gm
10-584 750gm



Mallet, Lightweight
10-585 19cm
Stainless Steel and Aluminum
Head diameter 25.0mm
Weight 7 oz 200 grams
Head Weight: 4 oz 113 grams

Nylon Caps Left & Right FOR 10-585 (PAIR)
10-586
2.5cm



Mallet #49
10-587 19.5cm
Head diameter 22.0mm
Weight 7 oz 200 grams
Head Weight: 5oz/150 grams



Mead Mallet
10-588 19cm
Head diameter 26.0mm
Weight 11 oz 315 grams
Head Weight: 6 oz 170 grams



Heath Mallet, Heavyweight
10-589 19cm
Head diameter 40.0mm
Weight 2 lbs. (907 grams)
Head Weight: 20 oz (567 grams)



Orthopedic Mallet
10-590 27.5cm
Lightweight
Solid, Head diameter 35.0mm
Weight 2 lbs. (907 grams)
Head Weight: 1 lb. (454 grams)



Orthopedic Mallet
10-591 28cm
Heavyweight
Solid, Head diameter 50.0mm
Head Weight: 2 lb. (900 grams)



Ortho Mallets
10-592
26.5cm (450g)



Phenolic Handle Mallet
10-593 28 cm
Head diameter 32mm
Head weight 16 oz (454 grams)
10-594 Head diameter 45mm
Weight 11 oz (312 grams);
Head weight: 2 lbs (907 grams),



Nylon Cap
10-593
For Phenolic Handle Mallet

MALLETS

Hammer | Martillos
Maillets | Martelli



Reprocussion Free Mallet Cap For 10-596

Reprocussion Free Mallet 10-595 28cm
Head diameter 30mm
Weight 1lb 5 oz (595 grams)
Head weight: 10 oz (283 grams)



Mallet 10-597 26cm
Plane (Nylon) convex (steel)
Head 30mm Ø
weight 675 grams.



Mallet 10-598 26cm
Head 42/30mm Ø
weight 530 grams



Mallet 10-599 26cm
Plastic Handle head 30mm Ø
weight 510 grams



Vickers Mallets 10-600 19 cm
25mmØ - 300g
nylon disks plastic



Herbert Mallets 10-601 19 cm
25mmØ - 300g
for ulnar head prosthesis plastic handle



Mallet 10-602 18cm
Made of Plastic
Head 30mm Ø
weight 125 grams



Mallet 10-603 26 cm
Made of Plastic with lead filling
Head 42mm Ø
weight 250 grams



Mallet 10-604 22.5 cm
Disks & Plastic Handle
Head 37mm Ø
weight 370 grams



Spare Facing (pair) 10-605 Plastic



Mallet 10-606 26 cm
Made of Plastic with lead filling
Head 42 mm Ø
weight 400 grams



Mallet 10-608 24cm
Plastic Handle
Head 30mm Ø
weight 480 grams



Mallet 10-609



Mallet 10-610



Mallet 10-611



Mallet 10-612

Raspatorien, Stobel
Periostótomos, Pílons

Rugines-raspatoires, Punzones
Periostotomi, Pestoni

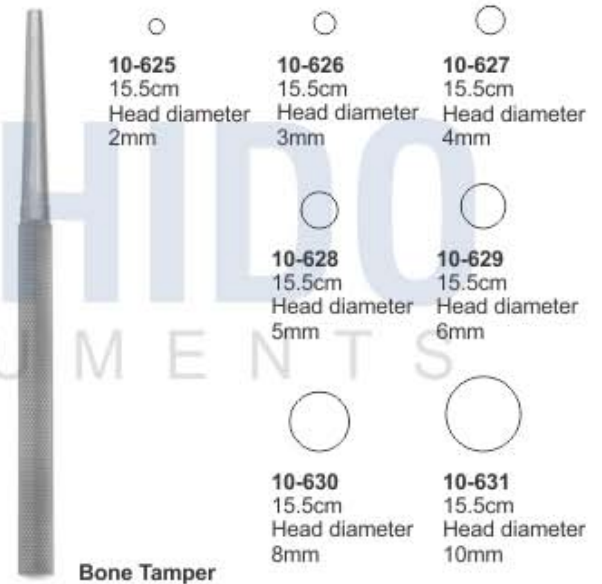
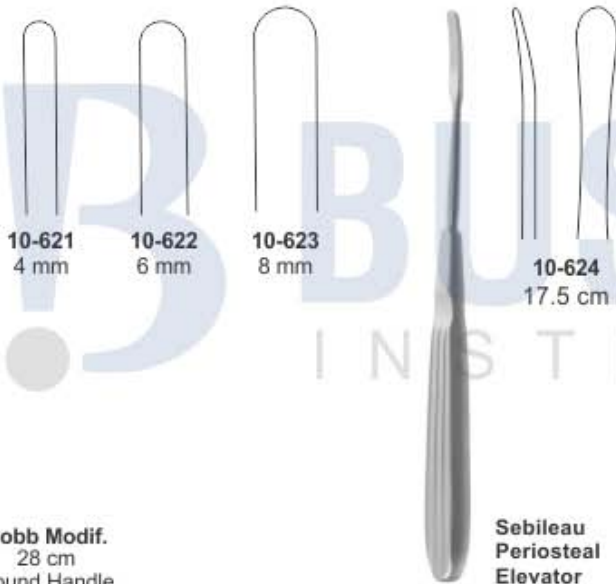
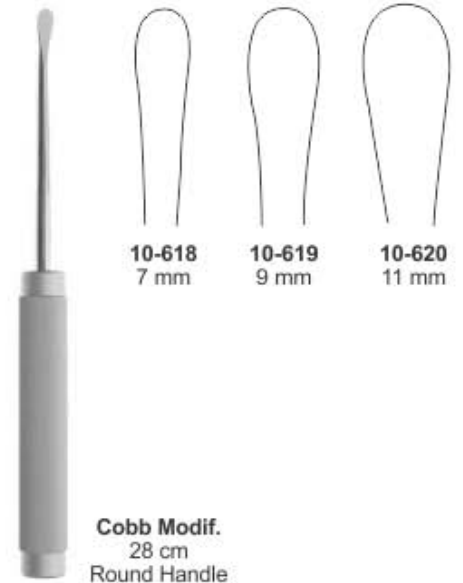
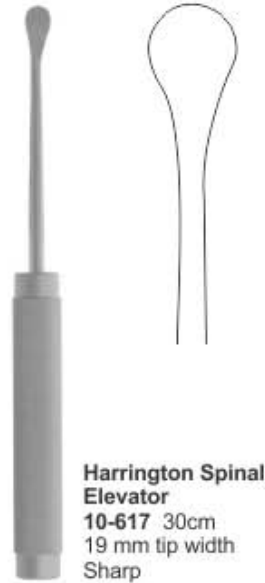
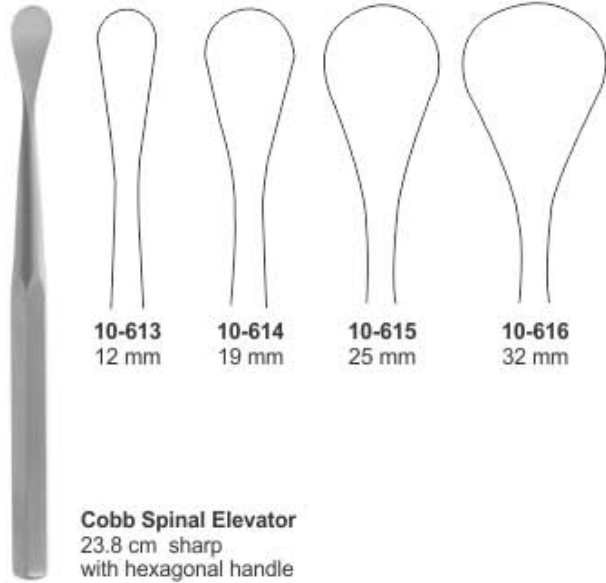

Scharfe Löffel
Curettes tranchantes

cucharillas cortantes
Cucchiai taglianti



Volkman Bone Curette

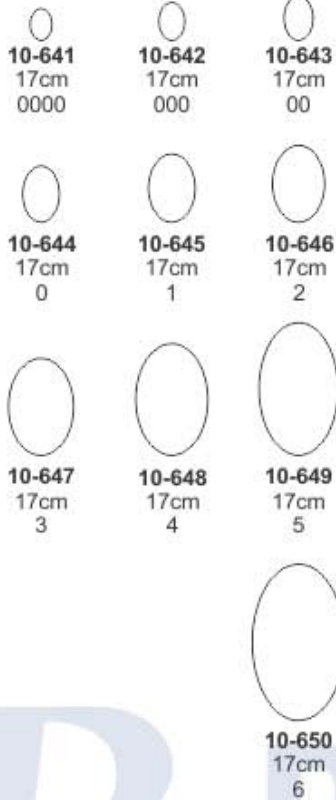

Schede Bone Curette
17cm

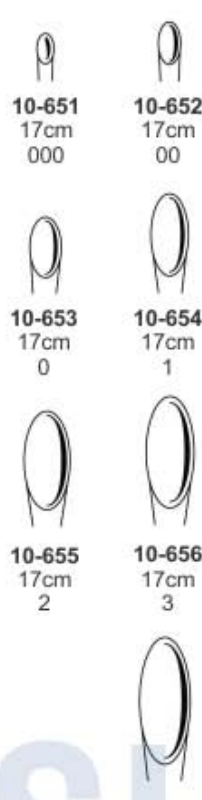

Bruns Bone Curette

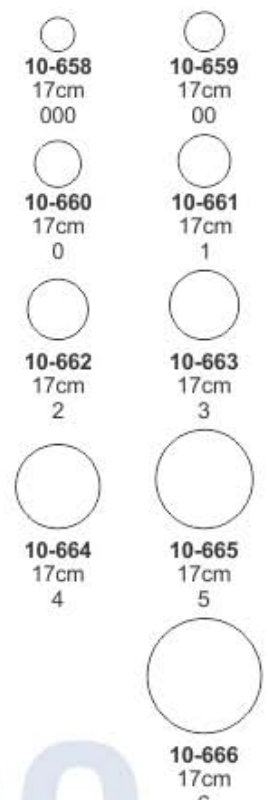

Spratt Bone Curette
/ Hollow Handle

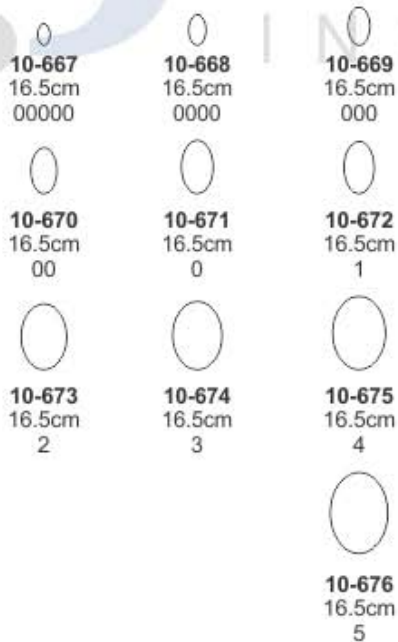

Halle Bone Curette
Flexible



Uffnorde Bone Curette Left
10-680 17.5cm



Uffnorde Bone Curette Right
10-681 17.5cm

Scharfe Löffel
Curettes tranchantes

cucharillas cortantes
Cucchiai taglienti



Bruns Bone Curette 23 cm

- Fig.1
10-682
- Fig.2
10-683
- Fig.3
10-684
- Fig.4
10-685
- Fig.5
10-686
- Fig.6
10-687
- Fig.7
10-688
- Fig.8
10-689
- Fig.9
10-690



Bone Curette Straight

- 10-691
20cm
000
- 10-692
20cm
00
- 10-693
20cm
0
- 10-694
20cm
1
- 10-695
20cm
2
- 10-696
20cm
3
- 10-697
20cm
4
- 10-698
20cm
5
- 10-699
20cm
6



Bone Curette Curved

- 10-700
20cm
000
- 10-701
20cm
00
- 10-702
20cm
0
- 10-703
20cm
1
- 10-704
20cm
2
- 10-705
20cm
3
- 10-706
20cm
4
- 10-707
20cm
5
- 10-708
20cm
6



Schroeder Bone Curette Sharp / rigid

- 10-709
30cm
1
- 10-710
30cm
2
- 10-711
30cm
3
- 10-712
30cm
4
- 10-713
30cm
5
- 10-714
30cm
6



Simon Bone Curette Sharp / rigid

- 10-715
24cm
0000
- 10-716
24cm
000
- 10-717
24cm
00
- 10-718
24cm
0
- 10-719
25cm
1
- 10-720
25cm
2
- 10-721
25cm
3
- 10-722
25cm
4
- 10-723
25cm
5
- 10-724
25cm
6

Scharfe Löffel

cucharillas cortantes

Curettes tranchantes

Cucchiai taglianti



10-725
3.6mm
000

10-726
4.4mm
00

10-727
5.2mm
0

10-728
6.8mm
1



10-729
2.8mm
0000

10-730
3.6mm
000

10-731
4.4mm
00

10-732
5.2mm
0



10-733
Straight

10-734
Down Angle

10-735
Up Angle



10-736
1.8mm
00000

10-737
2.0mm
0000

10-738
2.4mm
000

10-739
2.6mm
00

10-740
2.8mm
0

Bone Curette
25 cm
Straight

Daubenspeck Bone Curette
20 cm

Scoville Bone Curette
25 cm

Lempert Bone Curette
21.5 cm



10-741
5 mm

10-742
7 mm

10-743
9 mm

10-744
10 mm

10-745
12 mm



10-746
4 mm x 10 mm
straight

10-747
4 mm x 10 mm
up angle

10-748
4 mm x 10 mm
down angle

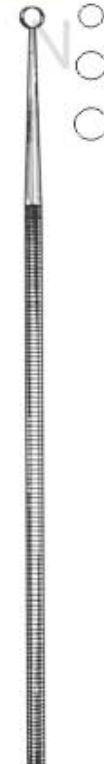

10-749
Ø 4 mm
straight

30°
10-750 Ø 3 mm
10-751 Ø 4 mm
10-752 Ø 5 mm

45°
10-753 Ø 3 mm
10-754 Ø 4 mm
10-755 Ø 5 mm

Cushing Bone Curette
23.5 cm
Pituitary Spoon,
malleable, silver-plated

Scoville Bone Curette
25 cm
Ruptured Disc Curette

Tay-Bronson Bone Curette
22 cm
Pituitary Curette, double-edged

Scharfe Löffel
Curettes tranchantes

cucharillas cortantes
Cucchiai taglianti

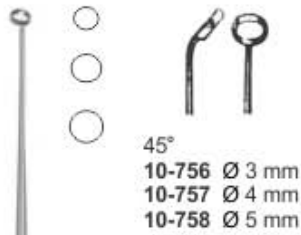

45°
10-756 Ø 3 mm
10-757 Ø 4 mm
10-758 Ø 5 mm



90°
10-759 Ø 3 mm
10-760 Ø 4 mm
10-761 Ø 5 mm



45° offset
10-762 Ø 3 mm
10-763 Ø 4 mm
10-764 Ø 5 mm



90° offset
10-765 Ø 3 mm
10-766 Ø 4 mm
10-767 Ø 5 mm



**Volkmann
Curette**
Oval / Oval

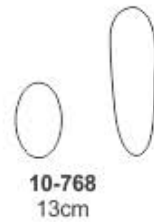

10-768
13cm

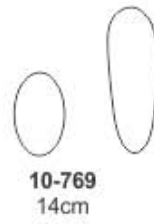

10-769
14cm



10-770
17cm



**Volkmann
Curette**
Round / Oval

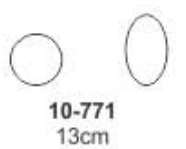

10-771
13cm

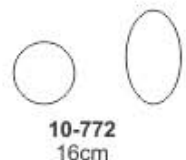

10-772
16cm

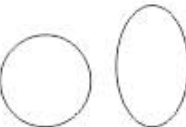

10-773
20cm

Ray Bone Curette, 19 cm
Pituitary Curette



Curette
10-774
21cm
round / oval



**Martini
Curette**
13.5cm



10-775
00
10-776
0
10-777
0
10-778
1
10-779
1
10-780
2



**Martini
Curette**
15.5cm

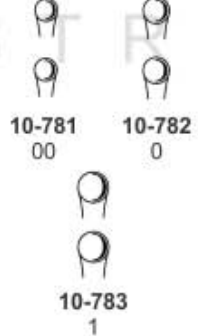

10-781
00
10-782
0
10-783
1



**Williger
Curette**
13.5cm

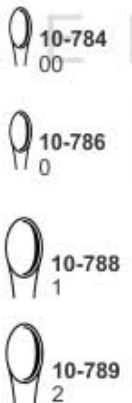

10-784
00
10-785
0
10-786
0
10-787
1
10-788
1
10-789
2



**Williger
Curette**
15.5cm



10-790
00
10-791
0
10-792
1

Scharfe Löffel | cucharillas cortantes
Curettes tranchantes | Cucchiai taglienti

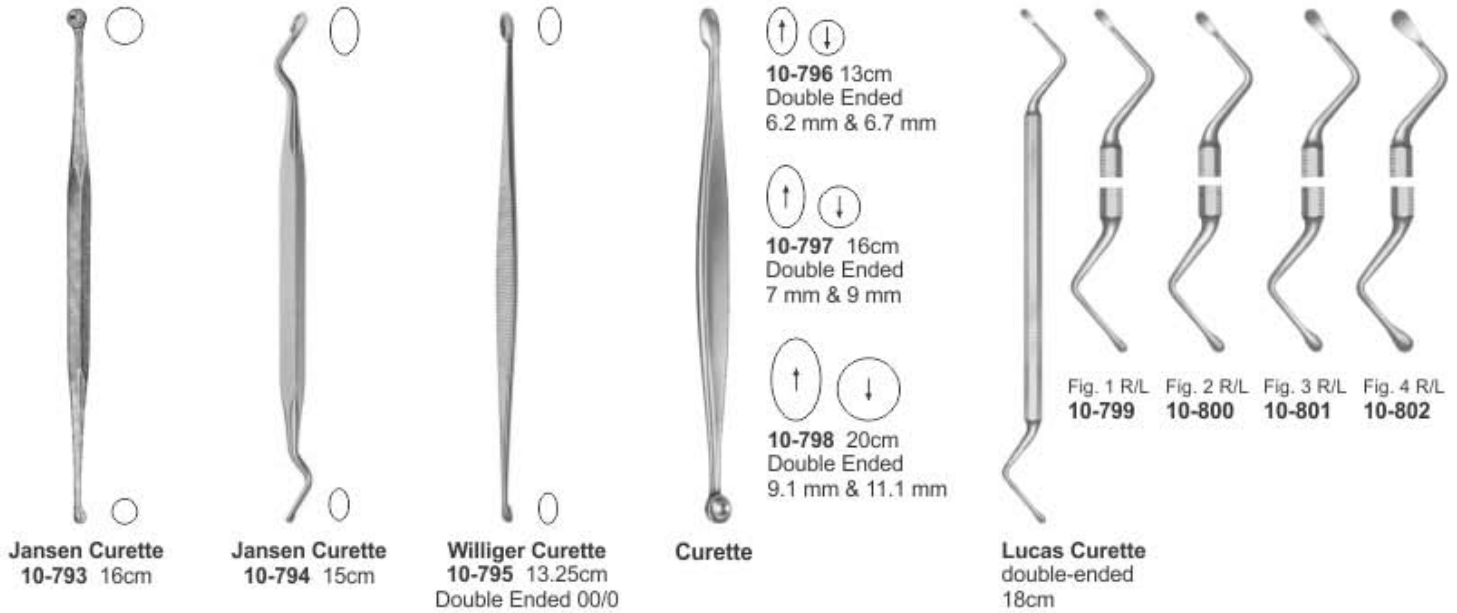

PERIOSTEAL ELEVATORS

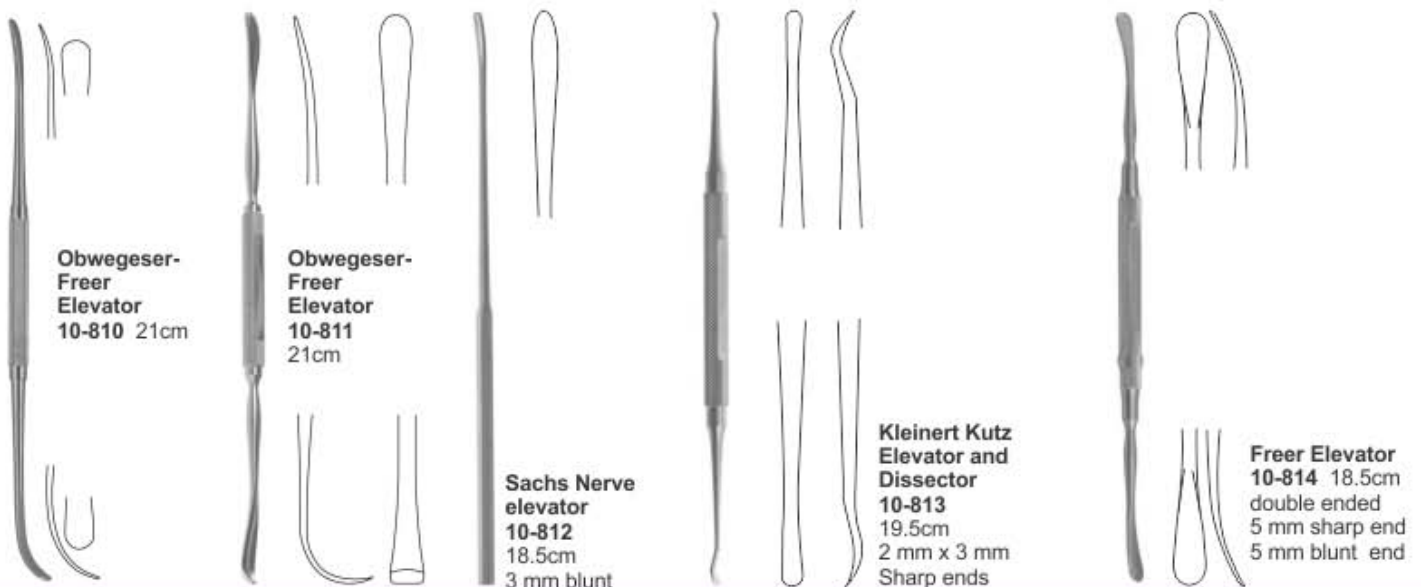
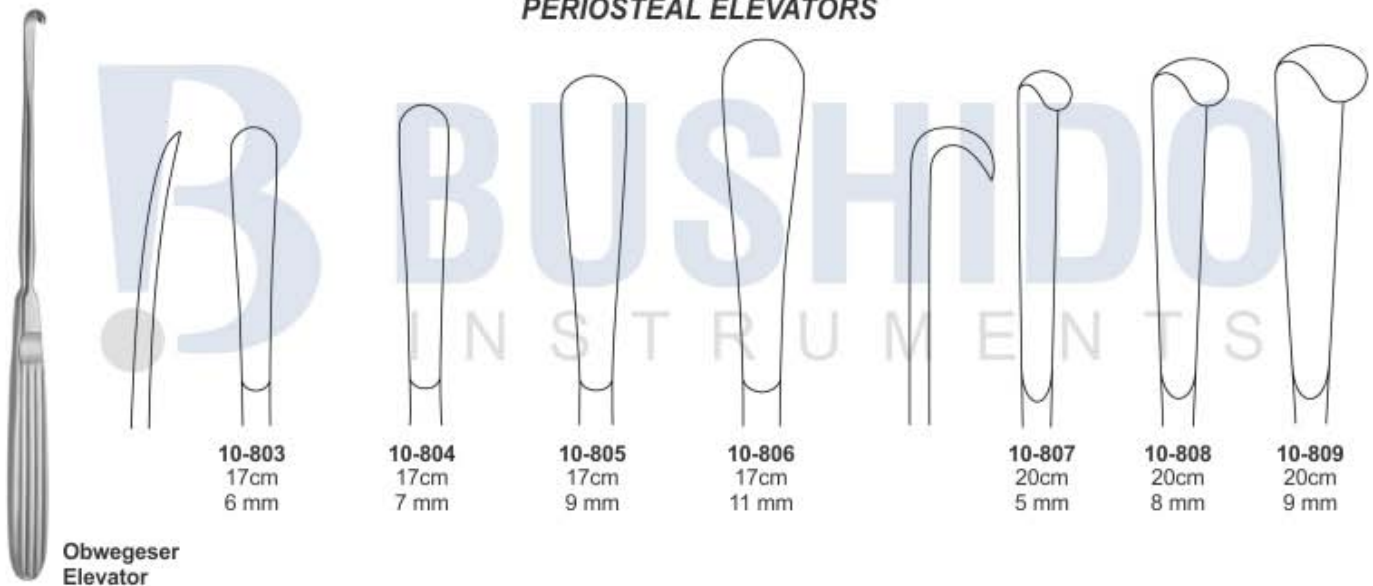

Raspatorien

Rugines-raspatoires

Periostótomos

Periostotomi

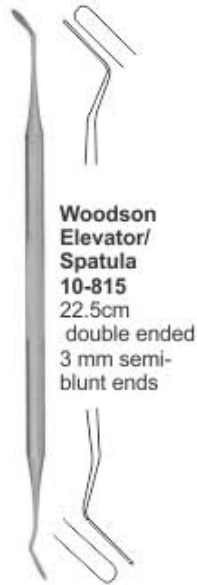

Woodson Elevator/ Spatula 10-815
22.5cm
double ended
3 mm semi-blunt ends

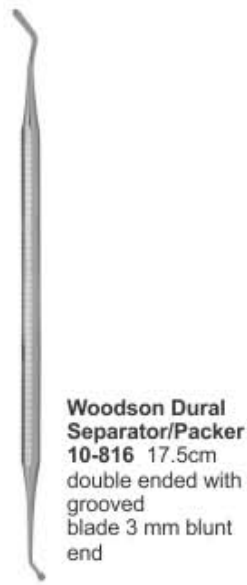

Woodson Dural Separator/Packer 10-816 17.5cm
double ended with grooved blade 3 mm blunt end

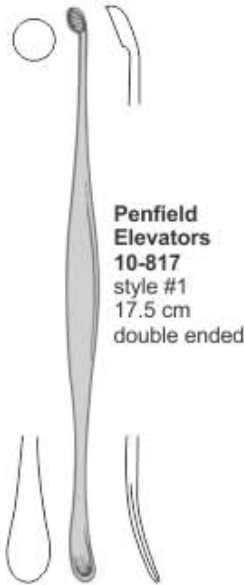

Penfield Elevators 10-817
style #1
17.5 cm
double ended

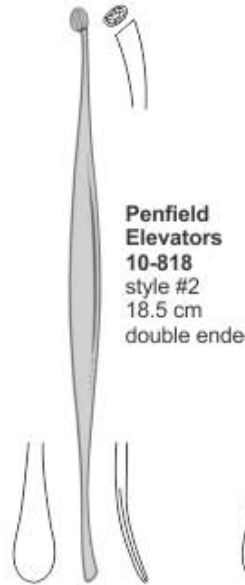

Penfield Elevators 10-818
style #2
18.5 cm
double ended

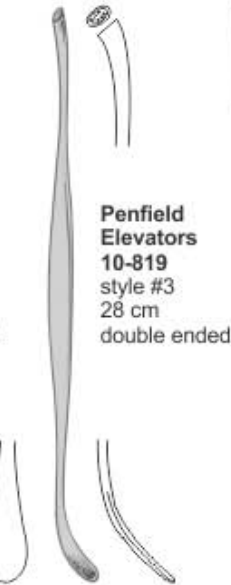

Penfield Elevators 10-819
style #3
28 cm
double ended



Penfield Elevators 10-820
style #4
28 cm
single ended



Penfield Elevators 10-821
style #5
18.5 cm
double ended

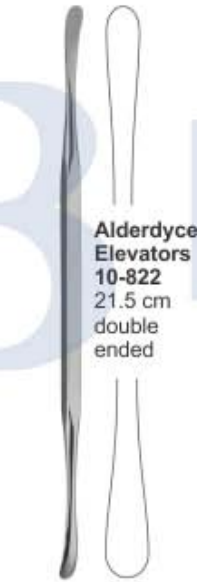

Alderdyce Elevators 10-822
21.5 cm
double ended

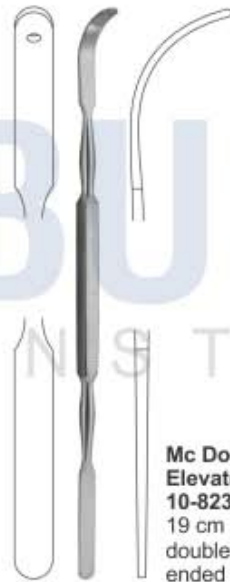

Mc Donald Elevators 10-823
19 cm
double ended



Watson-Cheyne Elevators 10-824
19 cm
double ended



Obwegeser Needle 10-825
17.5cm



Obwegeser Needle 10-826
23cm



Obwegeser Needle 10-827
18cm



Obwegeser Needle 10-828
14cm

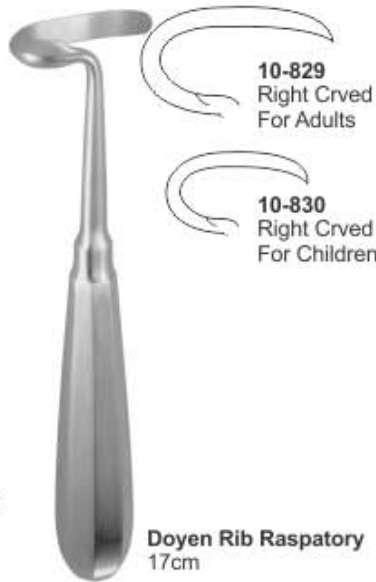

10-829
Right Crved
For Adults

10-830
Right Crved
For Children



10-831
Left Crved
For Adults

10-832
Left Crved
For Children



Sedillot Elevator 10-833
18.5cm
10-834
21cm

Raspatorien | Rugines-raspatoires
Periostótomos | Periostotomi



Crego Periosteal Elevator 10-835
15.5cm



Williger Elevator 10-836
13cm
5mm



Williger Elevator 10-837 4mm
10-838 6mm
16cm



Williger Elevator 10-839
16cm
5mm



Williger Elevator 10-840
16cm
6.5mm



Farabeuf-Collin Elevator 10-841
16cm
11mm
Straight



Farabeuf-Collin Elevator 10-842
16cm
11mm
Curved



Farabeuf Elevator 10-843
15cm
Straight



Farabeuf Elevator 10-844
15cm
Curved



Lambotte Elevator 10-845 5mm
10-846 10mm
10-847 15mm
10-848 20mm
10-849 25mm
21cm Straight



Lambotte Elevator 10-850 5mm
10-851 10mm
10-852 15mm
10-853 20mm
10-854 25mm
21cm Curved



Adson Elevator

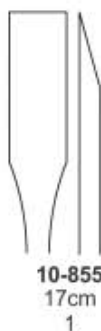

10-855
17cm
1



10-856
17cm
2

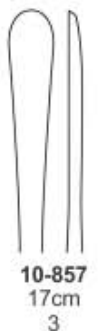

10-857
17cm
3



10-858
17cm
4



Quervain Elevator 10-859 06mm
19.5cm



Trelat Elevator 10-860 8mm
15cm

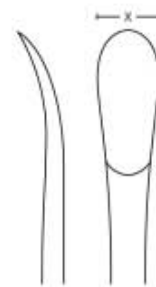

Raspatorien | Rugines-raspatoires
Periostótomos | Periostotomi

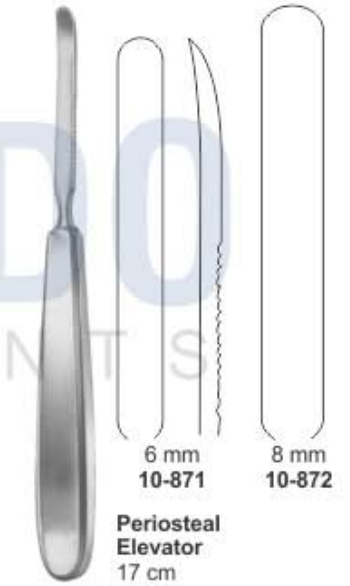
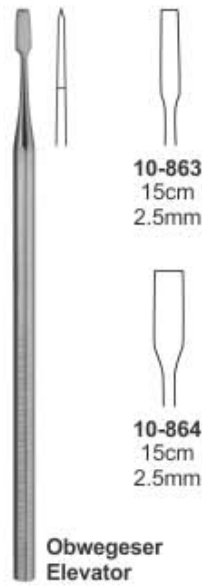
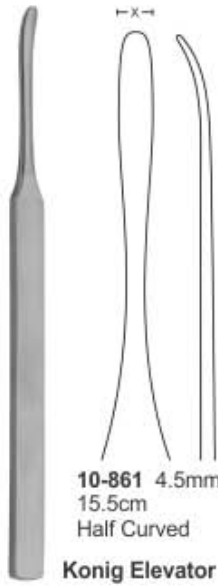

Raspatorien | Rugines-raspatoires
Periostótomos | Periostotomi

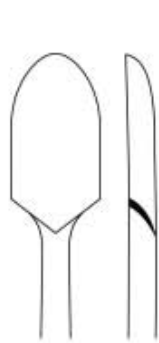

10-879
14mm
Straight
1

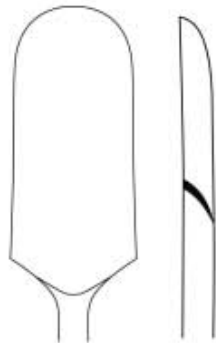

10-880
20mm
Straight
3

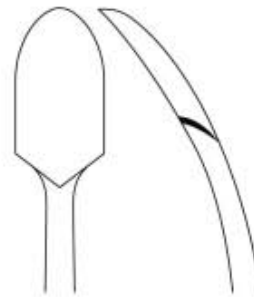

10-881
14mm
Curved
2

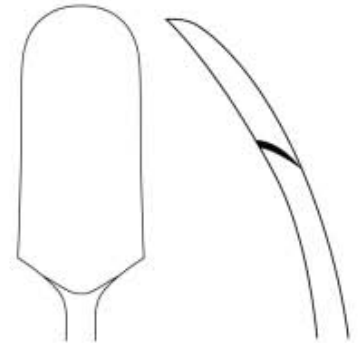

10-882
20mm
Curved
3

Ferozell Periosteal Elevator
20cm



Ferozell Periosteal Elevator
18cm

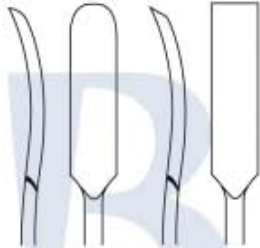

10-883
6mm
1

10-884
3mm
2



10-885
6mm
3



Periosteal Raspatories
10-886
18.5cm
cvd



Periosteal Elevator
10-887 18cm
Fiber/Phenolic Handle
blade 6mm



Hoen Periosteal Elevator
10-888
16.5cm



Chandler Bone Elevator
10-889 19cm
13 mm
10-890 20cm
20 mm
10-891 23cm
25 mm
10-892 25cm
31 mm



Key Periosteal Elevator 19cm
10-893
6 mm
10-894
12 mm
10-895
20 mm
10-896
25 mm
sharp,
slightly
curved



Pennybacker Periosteal Elevator
10-897
6 mm
17 cm sharp,
curved



Langenbeck Periosteal Elevator
10-898
15 mm
19 cm
sharp, slightly
curved



Cushing Periosteal Elevator 15 mm
10-899
Round Edge
10-900
Square Edge
18 cm

Raspatorien
Periostótomos

Rugines-raspatoires
Periostotomi



Hoen Periosteal Elevator
10-901 7mm, 16cm
10-902 15mm, 19cm
10-903 20mm, 19cm
Semisharp



Sayre Periosteal Elevator
10-904 17cm
one straight blunt
and one curved
sharp



Langenbeck Periosteal Elevator
10-905 7mm
10-906 10mm
20 cm Blunt

7 mm
10 mm



Cushing Periosteal Elevator
19cm
10-907
Left
10-908
Right



Cobb Periosteal Elevator
10-909 10mm
10-910 13mm
10-911 19mm
29cm
Spinal Raspatory

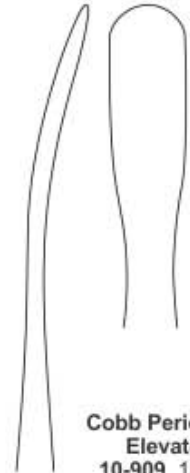

Key Periosteal Elevator

10-912
18cm
8mm

10-913
19cm
10mm

10-914
19cm
12mm

10-915
20cm
19mm

10-916
21cm
25mm



Cobb Periosteal Elevator
10-917 23.4cm
Hex Handle



Darrach Elevator
10-918 26cm
19mm
10-919 35cm
25.4mm
Blunt, Slightly
Curved



Carroll Periosteal Elevator
10-920 14cm
sharp, double ended
3 mm round end,
10 mm flat end



Langenbeck Periosteal Elevator
19.5cm
10-921
blunt edge
10-922
sharp edge



Key Periosteal Elevator sharp edge
10-923 17.7 cm 6.5 mm width
10-924 18.5 cm 9.5 mm width
10-925 18.5 cm 12.7 mm width
10-926 20.0 cm 19.0 mm width
10-927 20.9 cm 25.0 mm width



Lane Bone Elevator
10-928
16cm
Serrated



Lane Bone Elevator
10-929
27cm



Trethowan's Bone Elevator
10-930
22cm



Bristow's Bone Lever
10-931
24cm

PERIOSTEAL ELEVATORS, MENISCOTOMY KNIVES

Raspatorien, Meniskotome

Rugines-raspatoires, Bisturies para meniscos

Periostótomos, Bistouries a menisques

Periostotomi, Bisturi per menisco



**St. Thomas
10-932**
16cm
Pointed



**St. Thomas
10-933**
16cm
Rounded



**Robinson's
10-934**
17cm



**Freer D
Septum
Knife
10-935**
15cm



**Bircher
Meniscotomy
Knife
10-936**
19cm



**Matson
Meniscotomy
Knife
10-937**
22cm



**Downing
Cartilage
Knife
10-938**
25.5cm
Curved tip,
Straight shaft



**Smillie
Meniscotomy
Knife
10-939** 16cm
Straight Shaft
Blade tip width
is 7.8mm
Straight tip



**Smillie
Meniscotomy
Knife
10-940** 16cm
Curved Shaft
Blade tip width
is 7.8mm
Curved left tip



**Kanadisches
Modell
Meniscotomy
knife
10-941**
20cm



**Kanadisches
Modell
Meniscotomy
knife
10-942**
20cm



**Meniscotomy
Knife
10-943** 18cm



**Neff Meniscotomy
Knife**



10-944
22cm
left

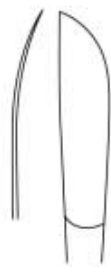

10-945
22cm
right



10-946
4mm

10-947
4.5mm

10-948
5.5mm

**Bunnell Tendon
Strippers**
23cm
Malleable shaft



10-949
Fig. 1
3mm

10-951
Fig. 3
5mm

**Bunnell
Tendon
Strippers**
15.2cm

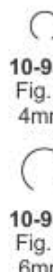

10-950
Fig. 2
4mm

10-952
Fig. 4
6mm

10-953
Fig. 5
7mm



**Fischer
Tendon
Strippers**
10-954
31cm

Sehnenstripper, Knochenhebel

enucleadores de tendones, Elevadores para huesos

Instruments a ecorcher les tendons, Leviers a os

Scollatendini, Elevatori per ossa



Bunnell Tendon Strippers
10-955 23cm
Tendon passer



Kleinert-Kutz Tendon Retriever
10-956
20cm
Serrated



Kleinert-Kutz Tendon Retriever
10-957
20cm
Serrated, flexible shaft



Brand Tendon Tunelling Forceps
10-958 15cm
10-959 19cm
10-960 24cm
Straight, serrated
2 x 3 teeth



Hohmann Bone Elevator
10-961 43mm
24.5 cm



Hohmann Bone Elevator
10-962 22mm
26cm



Hohmann Bone Elevator
10-963 33mm
28cm



Hohmann Bone Elevator
10-964 24mm
26.5cm



Hohmann Bone Elevator
10-965 22mm
26cm



Capsule Retractor
10-966 25.5cm
3 sharp-pronged,
22mm width blade



Bristow-Bankart Humeral Retractor
10-967 19cm
Double-pronged,
25mm width x 102mm
depth blade



Bristow-Bankart Soft Tissue Retractor
10-968 20cm
3-pronged
21mm width blade,



Humeral Head Retractor
10-969 22cm
18mm width blade



Hohmann Bone Elevator
10-970 22cm
08mm width blade
10-971 23cm
10mm width blade



Hohmann Bone Elevator
10-972 24cm
18mm



Hohmann Bone Elevator
10-973 24cm 70mm
10-974 28.5cm 35mm width blade
10-975 33cm 40mm width blade

Knochenhebel | *Elevadores para huesos*
Leviers a os | *Elevatori per ossa*



Hohmann Long Shank Retractor
10-976 23cm
43mm width blade



10-977 16cm
6mm width blade

Mini-Hohmann Bone Elevator



10-978 16cm
8mm width blade



Hohmann Bone Lever
10-979
15cm



Hohmann Bone Lever
10-980
15.4cm
Short tip



Hohmann Retractor
10-981
15cm
15mm width blade

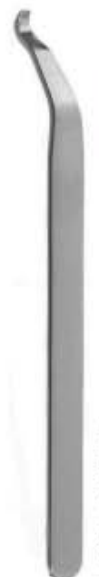

Hayes Hand Retractor
10-982
16cm
3mm width blade



Hayes Hand Retractor
10-983
15cm
6mm width blade



10-984
14cm
2.8mm

Bone Lever

10-986
14cm
6mm



10-985
14cm
4.5mm



Bristow Bone Lever
10-987
23cm



Lane Bone Lever
10-988
21cm



Periosteal Elevator 17.5cm
For Metacarpals Small
10-989 6 mm width
For Metacarpals Medium
10-990 10 mm width
Light Curve, Rounded End,
10-991 5 mm width
Contra Angled Curve
10-992 4.5 mm width



Hohmann Retractor
10-993 18cm
Small, width 6 mm
short, narrow tip



Hohmann Retractor
10-994 18cm
Small, width 8 mm
short, narrow tip



Hohmann Retractor
10-995 12.5cm
Finger Ring handle,
16mm width blade



Hohmann-Williger Retractor
10-996
16cm



Blount Retractor
10-997
17.5cm

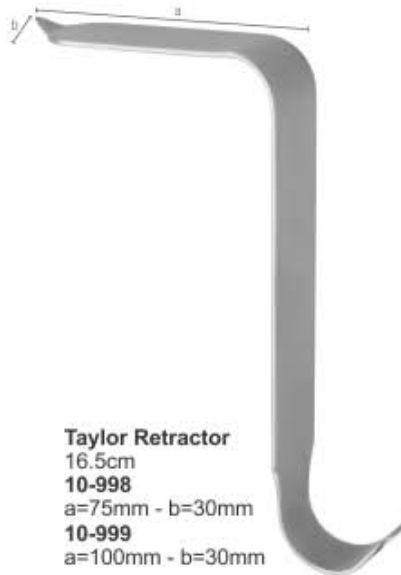

Taylor Retractor
16.5cm
10-998
a=75mm - b=30mm
10-999
a=100mm - b=30mm



Cushing Vein Retractor
10-1000 22.5cm
with fenestrated handle
Blade 12 mm width x 10 mm



Cushing Decompression Retractor
10-1001 21.5cm
with fenestrated blade and handle
Blade 13 mm width x 22 mm



Scoville Nerve Retractor
10-1002
24cm
7 mm straight



Scoville Nerve Retractor
10-1003
24 cm, 7 mm angled



Taylor Retractor
17cm
10-1004 30 x 75 mm
10-1005 30 x 100 mm



Hibbs Retractor
10-1006
25 x 75 mm, 23cm
10-1007
25 x 80 mm, 24cm



Meyerding Retractor
10-1008
16 X 50 mm, 20cm
10-1009
25 X 75 mm, 23cm
10-1010
50 X 90 mm, 24cm



Nail Extracting Forceps
10-1011
14cm



Nail Extracting Forceps
10-1012
14.5cm

Orthopädie, Sehnenstripper

Orthopédie, enucleadores de tendones

Ortopedia, Instruments a ecorcher les tendons

Ortopedia, Scollatendini

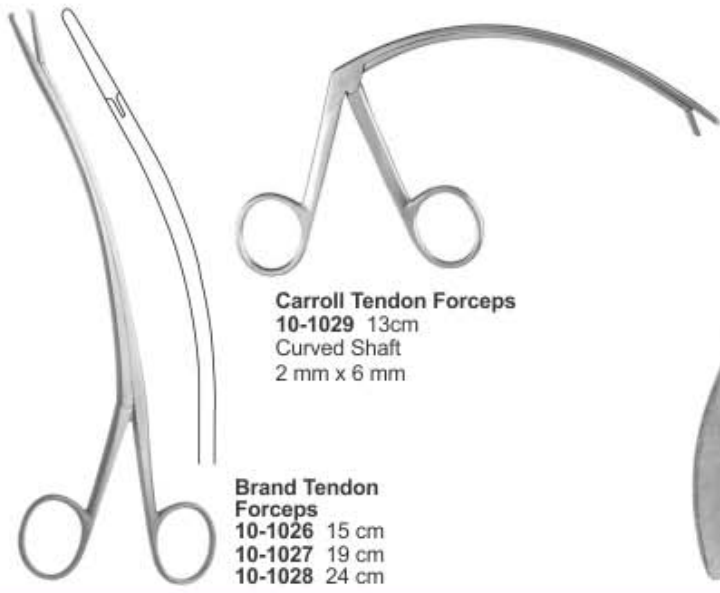
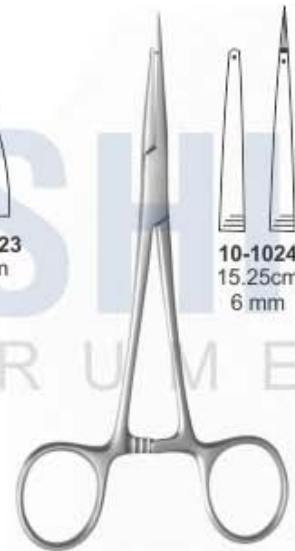

Sehnenstripper, Technische Zangen

enucleadores de tendones, Pinzas tecnicas

Instruments a ecorcher les tendons, Pinces techniques

Scollatendini, Pinze tecniche



Flat Nose Pliers
10-1033
13.5cm
Broad, 4mm tip,



Flat Nose Pliers
10-1034 16.5cm
Combination plier and
cutter



Needle Nose Pliers
10-1035 13.5cm



Flat Nose Pliers
10-1036
15cm Delicate,
1.5mm tip



K-Wire Extraction Pliers
W/Screw Lock
10-1037
13cm, 3mm tip



Flat Nose
K-Wire Pliers
10-1038
14cm
10-1039
17cm



Nose Pliers
10-1040
17cm



Utility Technical
Forceps Pliers
10-1041 19cm
adjustable



Wire Bending
Forceps
10-1042 18.5cm



Flat Nose Plier
10-1043 18.5cm
parallel grip, incorporated
cutter, for hard wires up to
1.6mm

Technische Zangen | Pinzas tecnicas

Pinces techniques | Pinze tecniche



Locking Plier
10-1044 18cm
10-1045 20cm
10-1046 24cm



Plate Bending Plier
10-1047 20cm
for plates up to 2.7mm
10-1048 24cm
for plates up to 4mm



Locking Plier
10-1049 22cm
10-1050 25cm
10-1051 30cm
Locking plier, only
10-1052 30cm
with holding pins
10-1053 46cm
with extraction device



Needle-Nose Locking Pliers
10-1054



Needle-Nose Locking Pliers
10-1055



Needle-Nose Locking Pliers
10-1056



Flat Nosed Plier
10-1057 18cm
parallèll, with lateral
wire cutter



Cast Spreader Model Usa
10-1058 23cm
3 Prong



Nail Extractor
10-1059 16cm
with Longitudinal Groove
(for Intramedullary Gliding Nails)

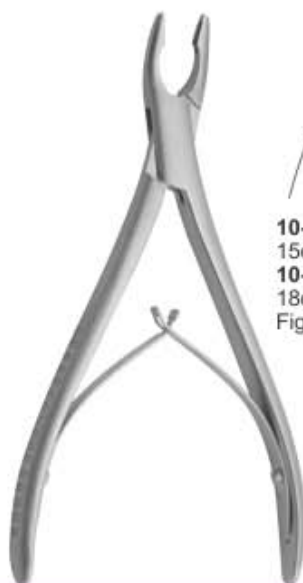

10-1060
15cm
10-1061
18cm
Fig.1



10-1062
15cm
10-1063
18cm
Fig.2

Luer Bone Rongeur
Single action
Curved, 8 x 12mm

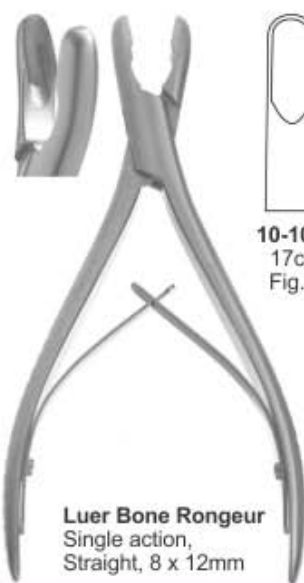

10-1064
17cm
Fig. 1

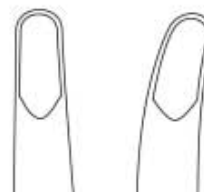

10-1065
17cm
Fig. 2

Luer Bone Rongeur
Single action,
Straight, 8 x 12mm



Friedmann Bone Rongeur
10-1066 14.5cm
Single action, Curved,
4 x 11mm

Hohlmeißelzangen
Pinzas gubias

Pinces-gouges
Pinze-sgorbie

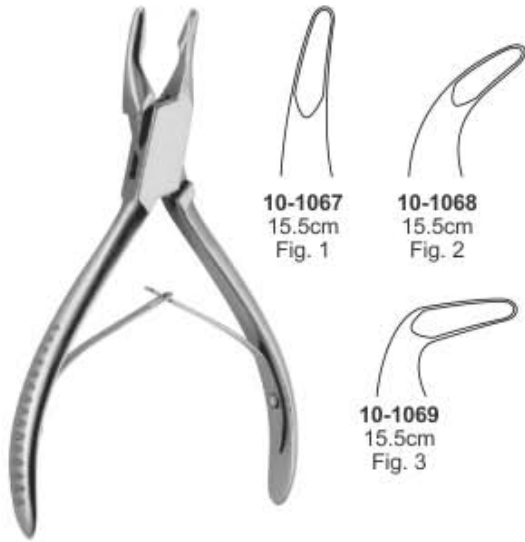

Blumenthal Bone Rongeur

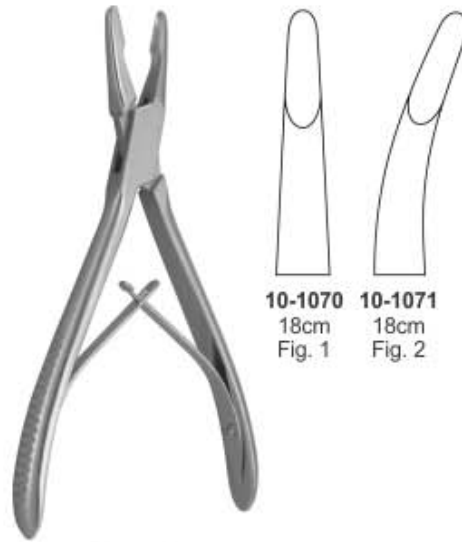

Jasen Bone Rongeur

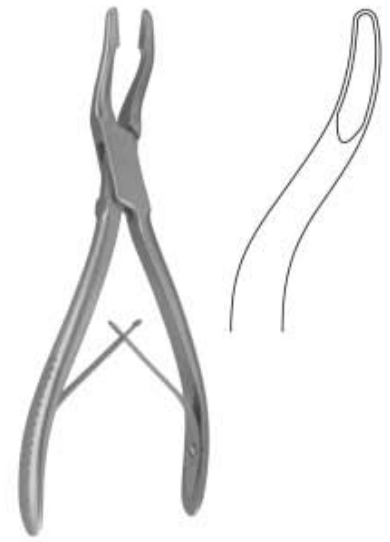

Jansen Bone Rongeur
10-1072 19cm



Stellbrink Bone Rongeur

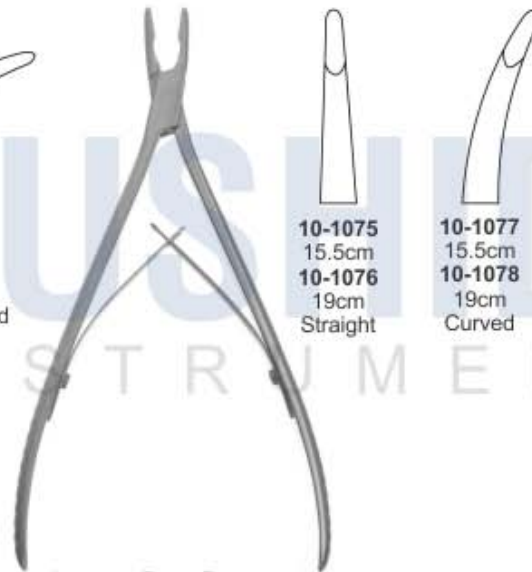

Lempert Bone Rongeur



Rongeur #4
10-1079 14cm
Rongeur #4A
10-1080 16.5cm
Single action,
Curved, 4 x 9mm



Chichirelli (Blumenthal) Rongeur
10-1081 15cm
Single action, Curved 45°,
4 x 13mm



Dean (Blumenthal) Rongeur
10-1082 15cm
Single action,
Curved 90°, 4 x 11mm



Dean Rongeur
10-1083 14.5cm
Single action
Curved, 3mm

Hohlmeißelzangen

Pinces-gouges

Pinzas gubias

Pinze-sgorbie



Hartmann Bone Rongeur
10-1084 18.5cm
Single action
Curved, 4 x 14mm

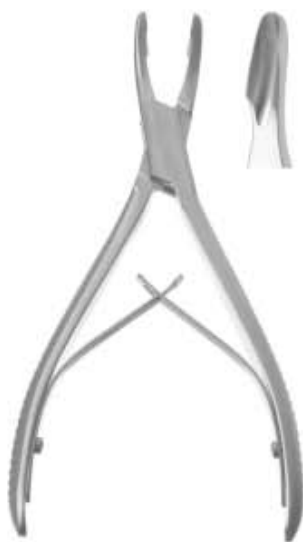

Mead Bone Rongeur
10-1085 16.5cm
Single action,
Curved, 5 x 13mm



Cleveland Bone Rongeur
10-1086 14cm
10-1087 17cm

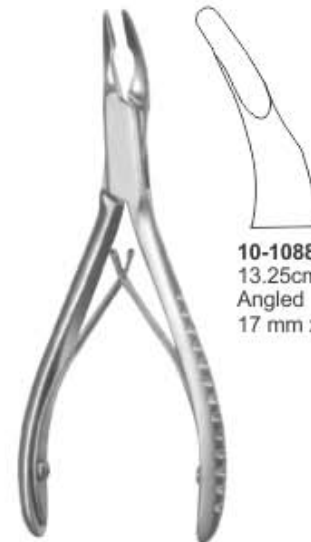

Universal Bone Rongeur

10-1088
13.25cm
Angled
17 mm x 3.5 mm



Bane Bone Rongeur

10-1089
18cm
Single action
Curved,
3 x 16mm

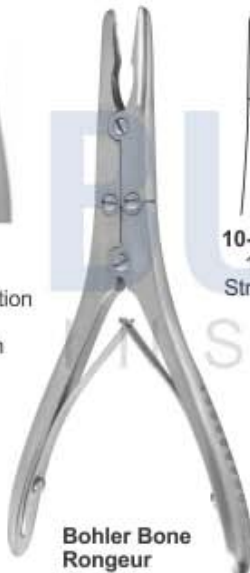

Bohler Bone Rongeur

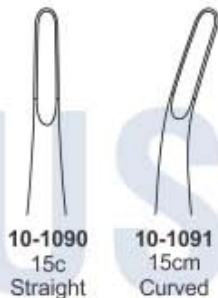

10-1090
15cm
Straight

10-1091
15cm
Curved



Zaufal-Jansen Bone Rongeur
10-1092 18cm
Double action
Curved, 5x15mm



Marquardt Bone Rongeur
10-1093 18cm



Beyer Bone Rongeur
18cm
10-1094 3 x 14mm
10-1095 4 x 15mm
Double action, Curved



Smith-Peterson Laminectomy Rongeur
10-1096 24cm
Double action,
Straight 3 x 16mm



Smith-Peterson Laminectomy Rongeur
10-1097 24cm
Double action
Curved 3 x 16mm

Hohlmeißelzangen
Pinzas gubias

Pinces-gouges
Pinze-sgorbie



Ruskin Rongeur
10-1098 18cm 4x16mm
10-1099 18.5cm 5x10mm
Double action, Curved on side



Ruskin Rongeur
10-1100 18.5cm
Double action, 6 x 16mm,
Straight, Curved



Ruskin Rongeur
10-1101 15.5cm Straight, 3.2mm
10-1102 15cm Curved, 2 x 15mm
10-1103 15cm Curved, 3 x 15mm
Double action,



Riskin Bone Rongeur



10-1104 15.5cm
10-1105 18cm
Double action
Straight, 2 x 14mm



10-1106 15.5cm
10-1107 18cm
Double action
Curved 2 x 14mm



Mayfield Bone Rongeur
10-1108 18cm



Stille-Ruskin Bone Rongeur



10-1109
23cm
Curved



10-1110
23cm
Straight



Leksell Bone Rongeur
10-1111 24.5cm 5 x 13mm
10-1112 24cm 8 x 14.5mm
Double action, Curved 50°



Leksell Rongeur
10-1113 24cm
6 x 15mm
10-1114 24cm
7 x 13mm
Double action, Curved



Leksell Rongeur
10-1115 24cm
3 x 18mm
Double action, Curved



Leksell Rongeur
10-1116 23cm
4 x 13mm
Double action
Fully curved



Stille Bone Rongeur



10-1117
23cm
4mm



10-1118
23cm
6mm



10-1119
23cm
8mm



Stille-Luer Rongeur Forceps



10-1120
23cm
10-1121
27cm
straight



10-1122
23cm
10-1123
27cm
curved



Echlin Duckbill Bone Rongeur 23cm



10-1124
2 x 12mm
Double action
Curved on side



10-1125
3 x 12mm
Double action
Curved on side



10-1126
4.5 x 11mm
Double action
Curved on side

Hohlmeißelzangen
Pinzas gubias

Pinces-gouges
Pinze-sgorbie

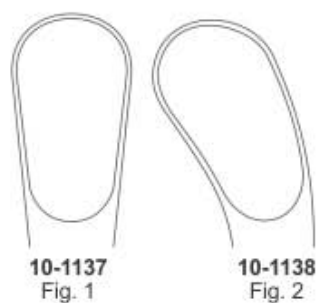

Hohlmeißelzangen
Pinzas gubias

Pinces-gouges
Pinze-sgorbie



Leksell Bonerongeur



- 10-1141 25cm 3 x 16mm
- 10-1142 23cm 5 x 16mm
- 10-1143 25cm 4.5 x 16mm
- 10-1144 25cm 6 x 16mm
- 10-1145 25cm 7 x 16mm
- 10-1146 25cm 8 x 16mm
- Double action, Curved 15°



Hakansson Bone Rongeur
10-1147 20cm



Kleinert-Kutz Bone Rongeur

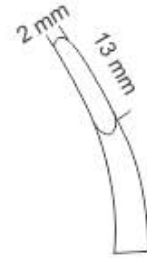

10-1148
15.25cm
2 x 13 mm



Ruskin-Mini Bone Rongeur

10-1149
15.25cm
Curved
18 x 5 mm



Syfert Rongeur

- 10-1150 35.5cm 4 x 16mm
- 10-1151 35.5cm 8 x 16mm
- 10-1152 35.5cm 12 x 16mm
- 10-1153 37cm 5 x 16mm
- Double action, Angled



Cottle-Kazanjian Bone
Cutting Rongeur Forceps
10-1154 19cm



Littauer / Liston Bone
Cutting Rongeur Forceps

10-1155
15cm
Straight,



Cleveland Bone Cutting
Rongeur Forceps

10-1156
15cm
curved

10-1157
17cm
curved



Liston Bone Cutting
Rongeur Forceps

10-1158
14cm
Angled

10-1159
17cm
Angled

10-1160
19cm
Angled

10-1161
22cm
Angled

Knochensplitterzangen

Pinzas cortantes para huesos

Pinces coupantes a os

Cesoie per ossa



10-1162 14 cm
10-1163 17 cm
10-1164 19 cm
10-1165 20 cm
10-1166 22 cm
Straight

Liston Bone Cutting Rongeur Forceps



Stille-Liston Bone Cutting Rongeur Forceps



10-1167
27 cm
Straight



10-1168
27cm
Angled 45°



Semb Bone Cutting Rongeur Forceps
10-1170 24cm



10-1169
27 cm
Angled 90°



Liston Key Horsley Bone Cutting Rongeur Forceps
10-1171 27cm



Horsley Bone Cutting Rongeur Forceps 10-1172 25cm



Ruskin Bone Cutting Rongeur Forceps
10-1173 20cm
Double-Action



Cleveland-Gardner Bone Cutting Rongeur Forceps



10-1174
16cm

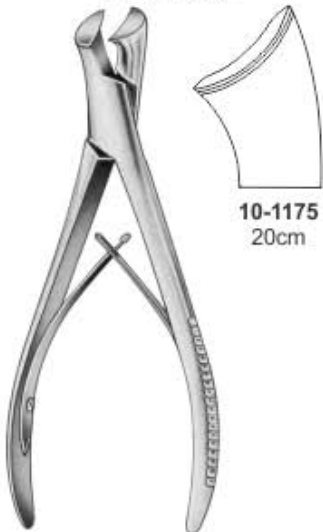

Markwalder Bone Cutting Rongeur Forceps

10-1175
20cm



Bone Cutting Rongeur Forceps
10-1176 15cm



10-1177
15cm
Straight



10-1178
15cm
Angled



Bohler Bone Cutting Rongeur Forceps

Knochensplitterzangen
Pinces coupantes a os

Pinzas cortantes para huesos
Cesoie per ossa



10-1179
18.5cm
Straight

Ruskin-Liston Bone Cutting Rongeur Forceps

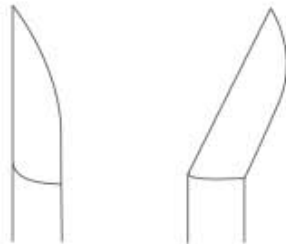

10-1180
18.5cm
Angled

Walton-Liston Bone Cutting Rongeur Forceps



10-1181
15cm
Straight



10-1182
15cm
Angled

Ruskin-Liston Bone Cutting Rongeur Forceps



10-1183 Straight
10-1184 Curved
10-1185 Angled
19cm deicate

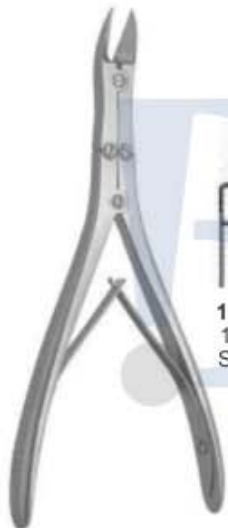

10-1186
17.5cm
Straight

Mc Indoe Bone Cutting Rongeur Forceps



10-1187
17.5cm
Curved



Mc Indoe Bone Cutting Forceps
10-1188 18cm
Angled, delicate,



Kleinert-Kutz Bone Cutting Forceps
10-1189 15cm
Straight, delicate,



Kleinert-Kutz Synovectomy Rongeur
10-1190 15cm 2 x 10mm
Double action,
Curved on side, delicate,



10-1191
27cm
Straight

Stille-Liston Bone Cutting Rongeur Forceps



Stille-Horsley Bone Cutting Forceps
10-1192 24cm



Liston Bone Cutting Rongeur Forceps

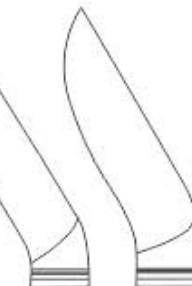

10-1193
23cm
Angled

10-1194
27cm
Angled

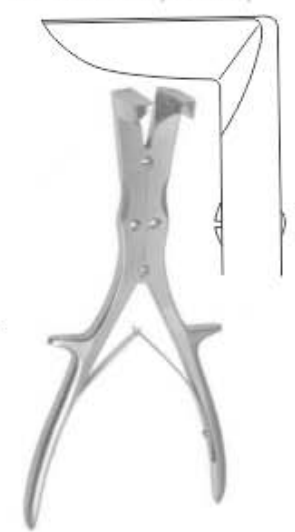

Liston-Stille Bone Cutting Rongeur Forceps
10-1195 26cm

Drahtschneidezangen
Pinces coupantes

Alicates para cortar alambre
Pinze taglia Filo

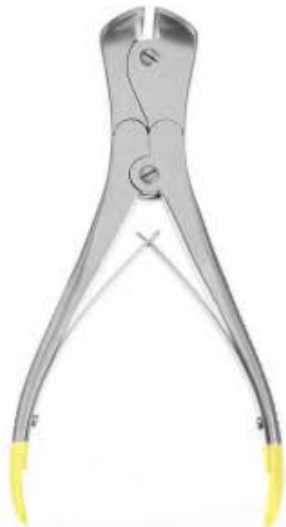

Vital Wire Cutter
10-1196 22cm
for hard wires up to 2.2mm,
for soft wires up to 3mm



Vital Wire Cutter
10-1197 22cm
for hard wires up to 2.2mm,
for soft wires up to 2.8mm



Vital Wire Cutter
10-1198 23cm
for hard wires up to 2.2mm,
for soft wires up to 3mm



Vital Wire Cutter
10-1199 18cm
for hard wires up to 1.5mm,
for soft wires up to 2mm



**Pin Puller W/
Groove TC**
10-1200 14cm



Vital Wire Cutter
10-1201 18cm
for hard wires up to 1.7mm,
for soft wires up to 2mm



Vital Wire Cutter
10-1202 15cm
for hard wires up to 1mm,
for soft wires up to 1.5mm



Vital Wire Cutter
10-1203 14.5cm
for hard wires up to 1mm,
for soft wires up to 1mm



**Cannulated Wire
/ Pin Cutter**
10-1204 19cm
Cuts wire upto 1.6 mm



Hard Wire Cutter Cuts
10-1205 26cm
for hard wires up to 3mm



**Kirschner Wires &
Steinmann
Pins Cutter**
10-1206 57cm
up to 6mm



Side Pin Cutter
10-1207
57.5cm
Side cutting w/
carbide inserts
max. cap: 5/32"



**Vital Heavy
Duty Pliers TC**
10-1208
22cm
Grip Forceps,
Combined
with cutter



**Vital Wire
Extraction
Pliers T.C**
10-1209 5mm
10-1210 7mm
18cm

Drahtschneidezangen
Pinces coupantes

Alicates para cortar alambre
Pinze taglia Filo



Side Cutter
10-1211 18.5cm
Welded carbide jaws
max capacity. 1.6mm



Delicate Wire Cutter
10-1212 12.5cm
Side cutting w/ carbide inserts
max capacity. 0.7mm



Front & Side Wire Cutter
10-1213 17cm
Front and side cutting w/ carbide inserts,
double action. Max capacity. 1.6mm



Double Action Wire Cutter
Angled, Side cutting w/
carbide inserts
10-1214 17cm
max cap 1.6mm
10-1215 21.5cm
max cap. 2.4mm



Flush Wire Cutter
10-1216 17cm
Front and side cutting w/ carbide inserts,
double action. Max capacity. 1.5mm



Wire Forceps
10-1217 17cm
Straight, serrated 5.4 mm tip



Pin Cutter Small
10-1218 26cm
Max cap: 3.2mm



Pin Cutter Medium
10-1219 36.5cm
Max cap: 4.7mm



Large Pin Cutter
10-1220 57.5cm
Large, Straight, Max.
capacity 6.3mm



Stille Plaster Shear
10-1221 37cm



**Schumacher Sternum
Shears**
10-1222 21cm

Knochenhalteklammern - Knochenhaltezangen | Pinzas porta huesos - Pinzas para huesos

Daviers a os - Daviers porte-so

Tenaglie per ossa



Gerster-Lowmann Bone Clamp
10-1223 12cm
10-1224 14.5cm
10-1225 18cm, 28mm
10-1226 20cm, 35mm
10-1227 22cm, 40mm
1x2 Jaws



Lowmann Bone Clamp
10-1228 12cm
10-1229 15cm
10-1230 17cm
10-1231 18.5cm
10-1232 20cm



Lambert-Lowman Bone Clamp
10-1233 17.5cm
10-1234 20.3cm
2x2 Jaws

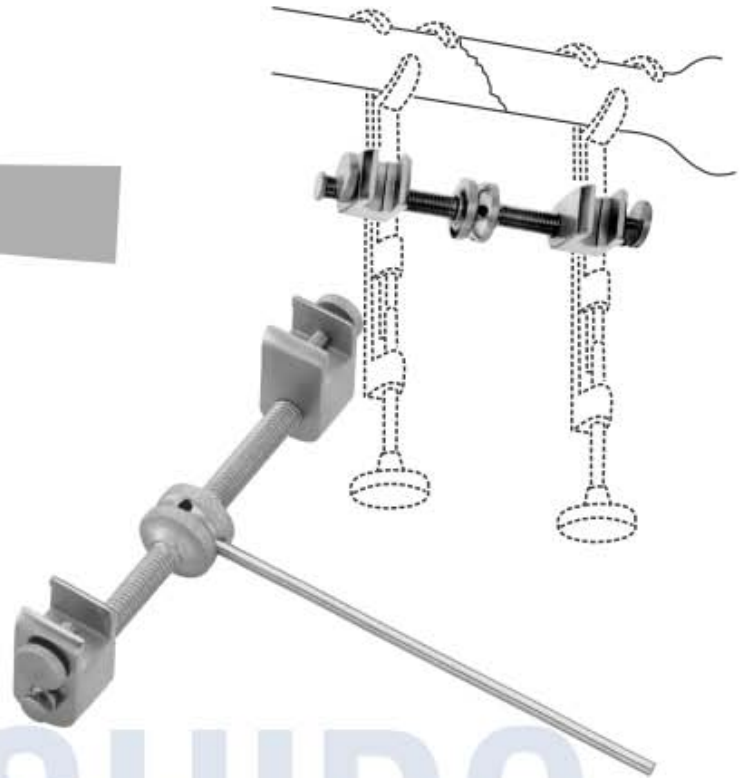

Gerster Bone Holding Clamp
10-1235 15cm



Gerster Bone Holding Clamp
10-1236

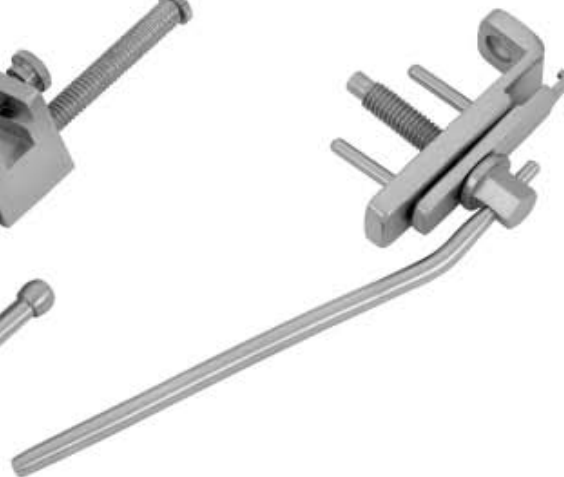

Gerster Bone Holding Clamp
10-1237



Parham-Martin Bone Clamp
10-1238 21cm
Straight



Parham Martin Bands
10-1239 19cm

Knochenhaltezaugen - Repositionszangen | *Pinzas para huesos - pinzas para reposicion*
Daviers porte-so-pinces de reposition | *Tenaglie per ossa - Pinze per riposizioni*



Bone Reduction Forceps
10-1240 13.5cm



Locke Phalangeal Forceps
10-1241 14cm



Lewin Perforating Bone Holding Forceps

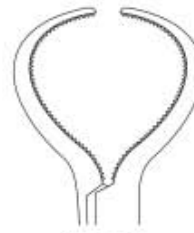

10-1242
17.5cm
serrated



Stagbeetle Bone Reduction Forceps
10-1243 Pointed tips, 13cm



10-1244
13.5cm
Angled
Serrated

Bone Reduction Orthopedic Forceps



Shoulder Percussion Awl
Pointed, 21.6cm
10-1245 Small
10-1246 Medium
10-1247 Large
10-1248 Pointed, 23.5cm



Meniscus Clamp
10-1249 13.5cm
Serrated



Meniscus Clamp
10-1250 13.5cm
Angled 20°, serrated



Preston Logamentum Flavum Forceps
10-1251 19cm
Curved, 1 x 2 teeth



Meniscus Clamp
10-1252 18cm
Straight, Curved shaft



Dingman Bone Clamp
10-1253 19cm
Straight, Serrated,
1 1/2" tip length, Curved shaft

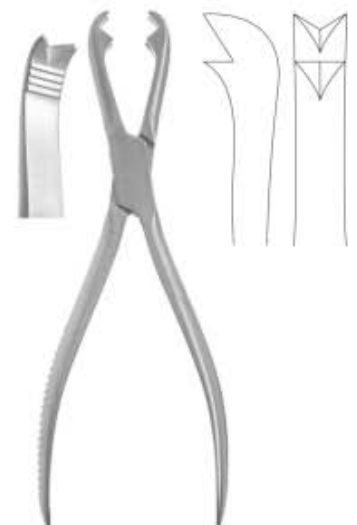

Fergusson Bone Holding Forceps
10-1254 21cm 2 x 2 teeth

Knochenhaltezaugen

Pinzas para huesos

Daviers porte-so

Tenaglie per ossa



10-1255
23cm

Van Buren Sequestrum Forceps
Curved on side, serrated



Langenbeck Bone Holding Forceps
10-1256 21cm



Semb Bone Holding Forceps
10-1257 19cm without ratchet
curved sideways deep teeth

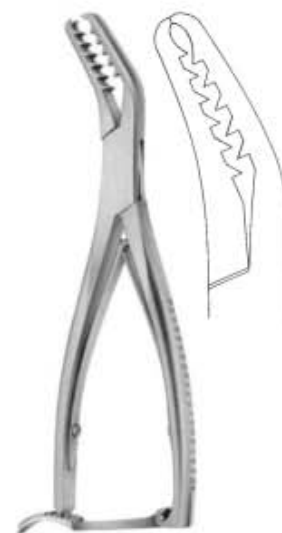

Semb Bone Holding Forceps
10-1258 20.3cm, with ratchet
curved sideways deep teeth

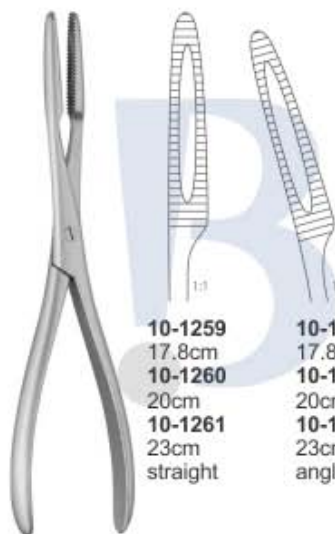

10-1259 17.8cm
10-1260 20cm
10-1261 23cm
straight

Sequestrum (Nircosis) Bone Holding Forceps



10-1262 17.8cm
10-1263 20cm
10-1264 23cm
angled on flat



10-1265 23cm
10-1266 26cm

Farabeuf Bone Holding Forceps with adjustable jaw



10-1267 26cm

Farabeuf-Lambotte Bone Holding Forceps with adjustable jaw

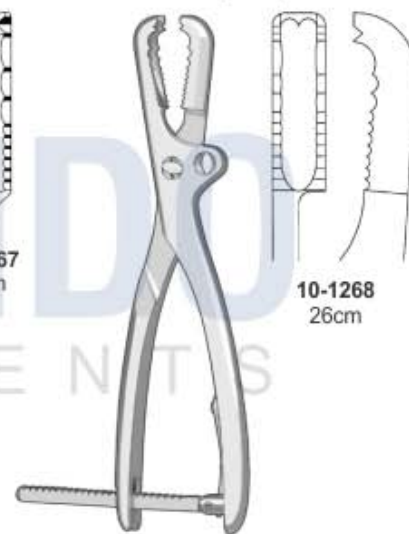

10-1268 26cm

Farabeuf-Lambotte Bone Holding Forceps with adjustable jaw



Bishop Bone Clamp
10-1269 22.5cm
Straight



Kern Bone Holding Forceps
10-1270 17cm
10-1271 24cm
without ratchet



Kern Bone Holding Forceps
10-1272 17cm
10-1273 24cm
with ratchet



10-1274 21cm
10-1275 27cm
10-1276 30cm

Hey Groves Bone Holding Forceps

Knochenhaltezaugen
Daviers porte-so

Pinzas para huesos
Tenaglie per ossa



- 10-1277**
33cm 11 mm tip W/ Ratchet
- 10-1278**
33cm 13 mm tip W/ Ratchet
- 10-1279**
43cm 13.5 mm tip W/ Ratchet
- 10-1280**
13cm 10 mm tip W/o Ratchet

Lane Bone Holding Forceps
Light Model



Lane Bone Holding Forceps
10-1281 33cm 13 mm tip
10-1282 43cm 12 mm tip
without ratchet



Ulrich Bone Holding Self Retaining Forceps

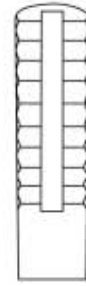

- 10-1283** 18 cm mini
- 10-1284** 22 cm
- 10-1285** 26 cm
- 10-1286** 28 cm
- Straight with speed lock

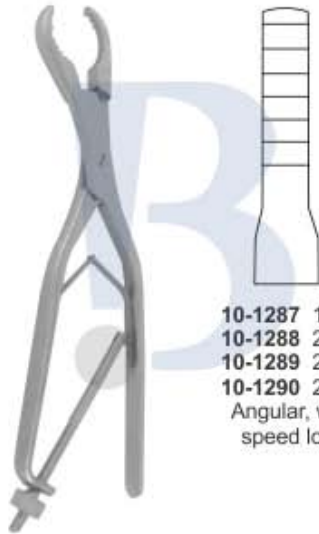

- 10-1287** 18cm
- 10-1288** 22cm
- 10-1289** 26cm
- 10-1290** 28cm
- Angular, with speed lock

Ulrich Bone Holding Forceps



- 10-1291**
28cm

Ulrich Bone Holding Forceps
Angular With Speed Lock
& swivel jaw



- 10-1292**
22cm
- 10-1293**
27cm
- 10-1294**
30cm

Lambotte Bone Holding Forceps
One Jaw Mobile
adjustable jaw



Lane Bone Holding Forceps
10-1295 31.5cm
10-1296 39cm



- 10-1297**
15 cm, 2.5mm
- 10-1298**
19 cm, 6.5mm
- 10-1299**
24 cm, 9.5mm
- 10-1300**
26 cm, 10mm
- 10-1301**
28 cm, 11mm

Lambotte Bone Holding Forceps
Self-Centering, with speed lock



Subacromion Spreader
10-1302 26.75cm Right
10-1303 26.75cm Left



Bone Reduction Forceps
10-1304 14cm
Serrated with pointed tips

Knochenhaltezaugen

Pinzas para huesos

Daviers porte-os

Tenaglie per ossa



Bone Reduction Forceps
10-1305 14cm Curved
10-1306 15cm Serrated



10-1307
14cm Serrated
10-1308
14cm Curved
10-1309
17cm Curved

Bone Reduction Forceps,
Pointed Tips



Semb Bone Holding Forceps
Curved on side
10-1310 19cm 4 x 5 teeth
10-1311 21cm 5 x 5 teeth



Martin Cartilage Bone Holding
Clamp Forceps
10-1312 19 cm Str.

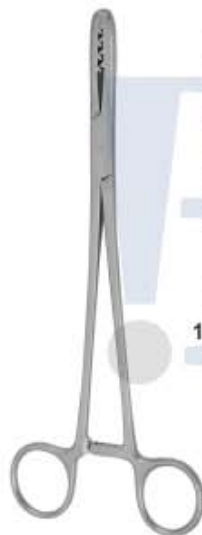

10-1313
20cm
Str.

Bircher-Ganske
Bone Holding Forceps



10-1314
20cm
Cvd.



10-1315
17.5cm
5.0mm

Verbrugge Bone
Holding Forceps



10-1316
25cm
9.5mm

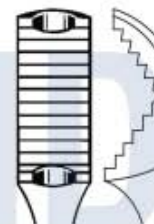

10-1317
26cm
10.5mm

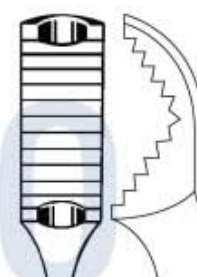

10-1318
27cm
12.0mm

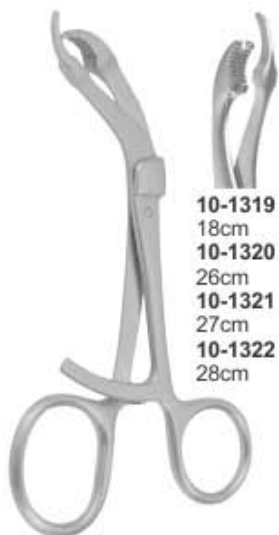

10-1319
18cm
10-1320
26cm
10-1321
27cm
10-1322
28cm

Verbrugge Bone
Holding Forceps
W/ Long Ratchet

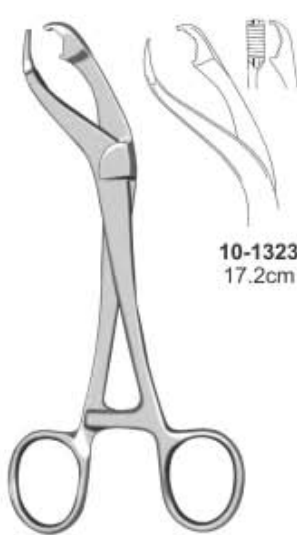

10-1323
17.2cm

Verbrugge Bone Holding
Forceps
with short ratchet



10-1324 15 cm
10-1325 19 cm
10-1326 24 cm
10-1327 26 cm
10-1328 29 cm

Verbrugge Self-Centering
Bone Holding Forceps
with long ratchet



Lane Bone Plate Holding
Forceps
10-1329 22cm

Knochenhaltezaugen
Daviers porte-so

Pinzas para huesos
Tenaglie per ossa



Verbrugge Bone Holding Forceps
10-1330 18cm



Verbrugge Bone Holding Forceps
10-1331 18cm



10-1332
25cm
10-1333
26cm
10-1334
27cm

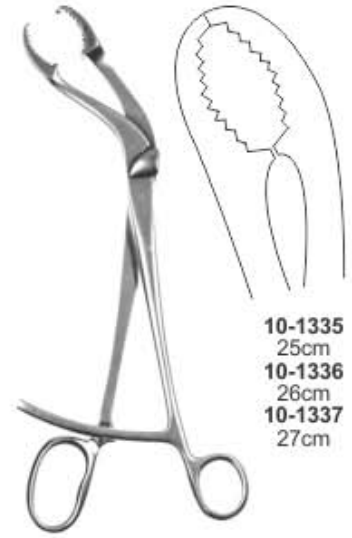

10-1335
25cm
10-1336
26cm
10-1337
27cm



Verbrugge Bone Holding Forceps
10-1338 18cm



10-1339
25cm
10-1340
26cm
10-1341
27cm



Bone Reduction Forceps
10-1342 13.5cm



Reill Bone Reduction Forceps
10-1343 17cm
Curved, pointed tips



Bone Reduction Forceps
10-1344 20.4cm
Pointed tips



Bone Reduction Forceps
10-1345 13.5cm
for maxillary reposition



Haase
10-1346 16.5cm
for mandibular fractures



10-1347
9.5cm

10-1348
9.5cm

Bone Holding forceps

Knochenhaltezaugen
Daviers porte-os

Pinzas para huesos
Tenaglie per ossa



Fibula Bone Holding Forceps
10-1349 22cm



Glenoid Perforating Forceps
10-1350 17cm
Lightly curved, pointed tips
Strongly curved, pointed tips



Reil Bone Holding Forceps
10-1351 17cm



Bone Reduction Forceps with Points
10-1352 20cm



Pelvic Reduction Forceps Asymmetric
10-1353 40cm



Malleolar Bone Holding Forceps
10-1354 21cm
Straight, 1 x 1 teeth



Patella Malleolar Forceps
10-1355 21cm

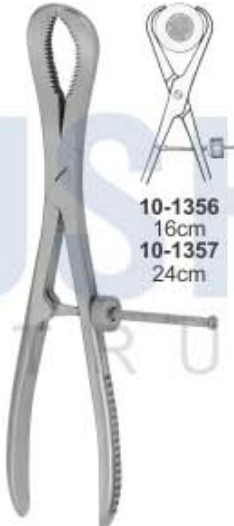

10-1356 16cm
10-1357 24cm

Reduction Forceps with Thread Lock



Reposition Forceps
10-1358 23cm



Pelvic Reposition Forceps
10-1359 19cm
10-1360 23cm



Pelvic Reposition Forceps
10-1361 25cm



Pelvic Reposition Forceps
10-1362 25cm
3 Balls Spikes



Pelvic Reduction Forceps Asymmetric with 3 ball Spikes
10-1363 25cm



Pelvic Reduction Forceps Asymmetric
10-1364 25cm



Pelvic Reposition Forceps
10-1365 40cm



Pelvic Reposition Forceps
10-1366 40cm

Handbohrapparate
Perforateurs a main

Perforadores de mano
Perforatori a mano



Bunnell Drill
10-1367 16cm
Opening up to 4mm
10-1368 spare key
light metal housing
longitudinally cannulated



Ralk Drill
10-1369 16cm
Opening up to 6.35mm
light metal housing
longitudinally cannulated



Plaster Saw Electronic Power
Volt #110
10-1370
Volt #220
10-1371

10-1372

10-1373
Spare Blade



Moore Drill And Bit Set Complete
10-1374



Fig. 1 10-1376 2.5mm
Fig. 2 10-1377 3.0mm
Fig. 3 10-1378 3.5mm
Fig. 4 10-1379 4.0mm
Fig. 5 10-1380 5.0mm
Fig. 6 10-1381 8.0mm
Fig. 7 10-1382 12.0mm
Fig. 8 10-1383 16.0mm
Fig. 09 10-1384
Fig. 10 10-1385 1.0mm
Fig. 11 10-1386 1.5mm
Fig. 12 10-1387 2.0mm

Stille Pattern Drill Set
10-1375
Complete set of stainless
drill bits and burs

Handbohrapparate
Perforateurs a main

Perforadores de mano
Perforatori a mano



10-1388
Hudson Brace 26.7cm
with standard thumb screw chuck

- C 10-1390 Hudson Bur, 9mm Diameter
- D 10-1391 Hudson Bur, 14mm Diameter
- E 10-1392 Hudson Bur, 16mm Diameter
- F 10-1393 Hudson Bur, 22mm Diameter
- G 10-1394 Cushing Perforator, for Hudson Brace
- H 10-1395 Hudson Cerabellar Extension, 4" for Hudson Brace
- I 10-1396 McKenzie Perforator for Hudson Brace

10-1389
Hudson Brace 27.9cm
with Improved Snap-Lock chuck



Jacobs
10-1397 28cm
opening up to 6.35mm



Hand Drill
10-1398
opening up to 6.35mm



T-Handle
10-1399
AO Coupling



Jacob's Chuck
10-1400 T-Handle and key
10-1401 only
10-1402 Key



Key Handle
10-1403



T-Handle
10-1404
for AO Coupling



Memorial Head Extractor
10-1405

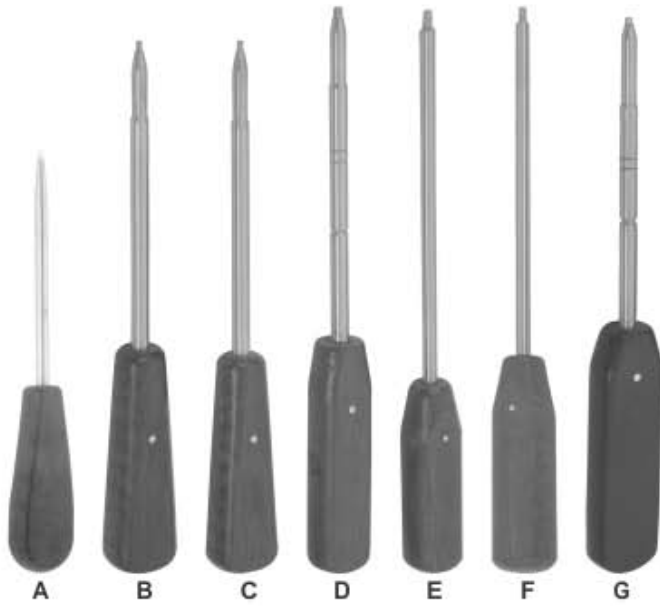

HEXAGONAL HEAD

	Size of screws	Head Size	Fiber-Handle	AO Coupling	Dental Coupling
A	1.5mm	1.5mm	10-1406	10-1409	10-1412
B	2.0mm				
C	2.7mm	2.5mm	10-1407	10-1410	
D	3.5mm				
E	4.0mm				
F	4.5mm	3.5mm	10-1408	10-1411	
G	6.5mm				



Parallel Target Device
10-1413
for guide wires 2mm

Mortising Chisel
10-1414

Wire Guide
10-1415
45mm

Wire Guide
10-1416
70mm

Countersink
10-1417

Countersink
10-1418

Countersink
10-1419

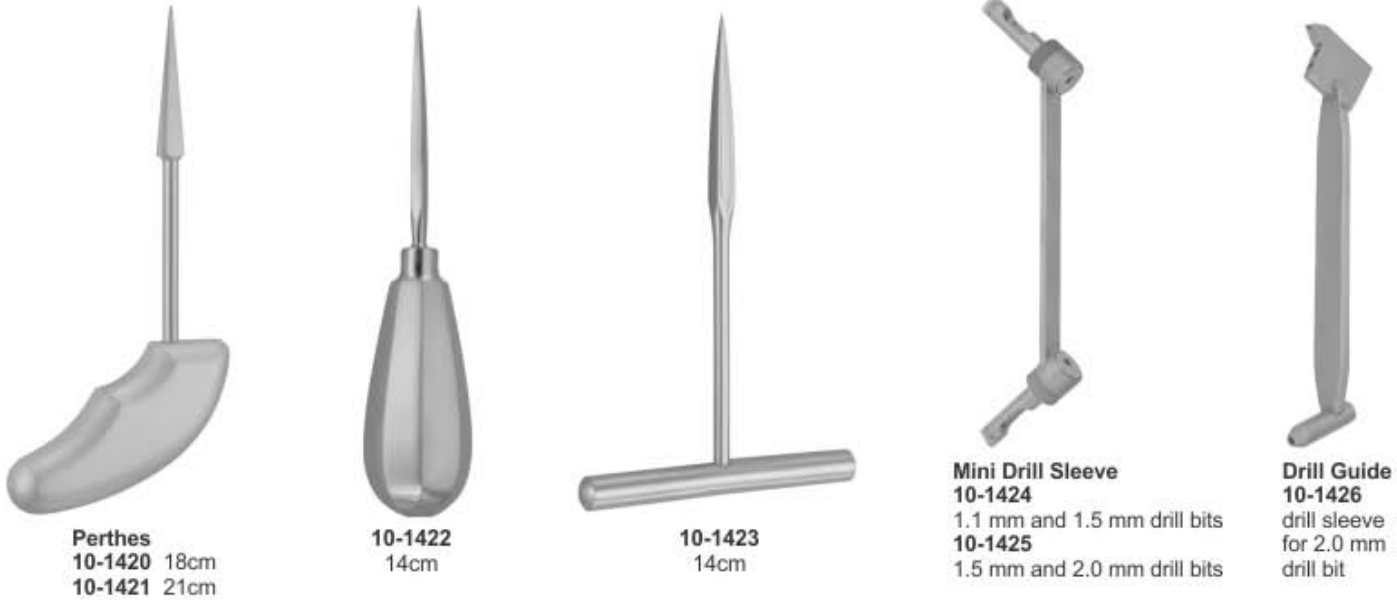

Perthes
10-1420 18cm
10-1421 21cm

10-1422
14cm

10-1423
14cm

Mini Drill Sleeve
10-1424
1.1 mm and 1.5 mm drill bits
10-1425
1.5 mm and 2.0 mm drill bits

Drill Guide
10-1426
drill sleeve for 2.0 mm drill bit



10-1427 Tap Sleeve, 2.0 mm ϕ
10-1428 Drill Sleeve, 2.7 mm ϕ
10-1429 Tap Sleeve, 2.5 mm ϕ
10-1430 Drill Sleeve, 3.5 mm ϕ



Neutral & Load Drill Guide
10-1431 1.5 mm for 2.0 mm Screws
10-1432 2.0 mm for 2.7 mm Screws
10-1433 2.5 mm for 3.5 mm Screws
10-1434 3.2 mm for 4.5 mm Screws



Tap Sleeve
10-1435
 3.5 mm



Tap Sleeve
10-1436
 3.5 mm also for used
 as 3.2 mm drill Guide



Tap Sleeve
10-1437
 4.5 mm



Drill Sleeve
10-1438 3.2 mm
 for Round Hole Plates



Drill Guide
10-1439 4.5 mm Screws
 Drill Bit 4.5 mm & 3.2 mm



Drill Guide
10-1440 6.5 mm Screws
 Drill Bit 3.2 mm



Drill Guide
10-1441 3.5 mm for neutral and
 compression Positioning Drill Bit 2.5 mm



C - Clamp
10-1442
 Drill Guide with thread
 for Drill Bit 4.5 mm



Insert Drill Sleeve
10-1443 2.7 / 2.0 mm Drill Bit 2.0 mm
10-1444 3.5 / 2.5 mm Drill Bit 2.5 mm
10-1445 4.5 / 3.2 mm Drill Bit 3.2 mm



Drill Small Pointed
10-1446 Drill Bit 3.5 mm



Drill Pointed Guide
10-1447 6.5 mm



Drill Pointed Guide
10-1448 6.5 mm

Plattenbiegevorrichtungen

Dispositivos de doblado de placas

Dispositifs de cintrage de plaques

Dispositivi di piegatura della piastra



**Bending Device
10-1449**
21.5cm
to bend straight
and angled plates



**Bending Device
10-1450**
21.5cm
to bend straight
and angled plates



**Rod Bender
10-1451**
to bend straight
and angled



**Universal Rod Bender
10-1452** 28.5cm
to bend straight
and angled



**Rod Bender
10-1453**
to bend straight
and angled



**Slotted Hammer
10-1454** 14mm



**Plate Bender
10-1455**



**Plate Bender
10-1456**



**Plate Bender
10-1457**



**Plate Bender
10-1458**



**Plate Bender
10-1459**



**Plate Bender
10-1460**



**Plate Bender
10-1461**

Extensionsbugel
Etriers pour extension

Estribos para extension
Archi per estensione



10-1462 18cm
Wire strainer for
kirschner wires



Kirschner Extension Bows
10-1463 x=95mm y=70mm
10-1464 x=100mm y=100mm
10-1465 x=120mm y=120mm
10-1466 x=155mm y=155mm
10-1467 x=200mm y=155mm
 with 3 traction hooks



Kirschner Extension Bows
10-1468 x=130mm
10-1469 x=185mm
10-1470 x=220mm
 with 3 traction hooks



Wrench
Kirschner
Extension Bows
10-1471
 14mm/17mm

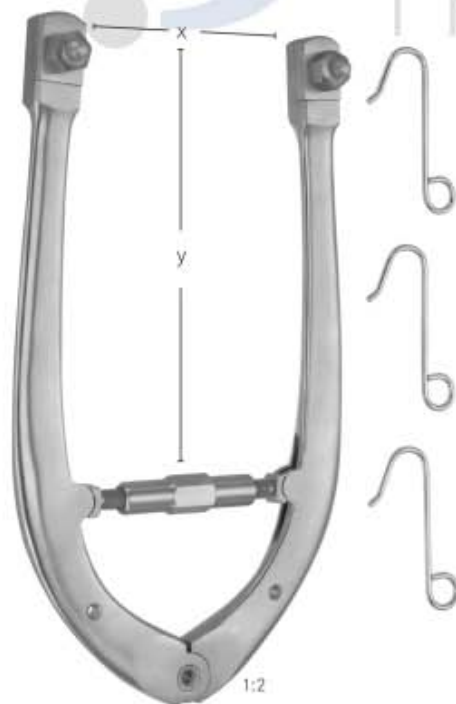

Kirschner Extension Bows
10-1472 x=180mm y=100mm
10-1473 x=270mm y=160mm
 with 3 traction hooks

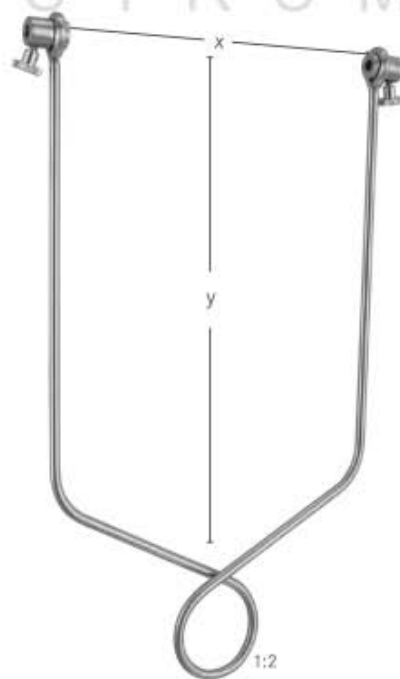

Bohler Kirschner Extension Bows
10-1474 x=75mm y=90mm
10-1475 x=90mm y=160mm
10-1476 x=110mm y=210mm
10-1477 x=150mm y=210mm
 with 3 traction hooks



Charnley-mueller
10-1478
 Compression Clamp



Screw Depth Gauges

- 10-1479 Mini Gauge, Longmeasures up to 30mm
- 10-1480 Small Gauge, Longmeasures up to 50mm
- 10-1481 Large Gauge, Longmeasures up to 100mm
- 10-1482 X-Large Gauge, Longmeasures up to 120mm



Screw Depth Gauges

- 10-1483 Mini Gauge, Longmeasures up to 30mm
- 10-1484 Small Gauge, Longmeasures up to 50mm
- 10-1485 Large Gauge, Longmeasures up to 100mm
- 10-1486 X-Large Gauge, Longmeasures up to 120mm



**Measuring Gauge
10-1487
for nail**

10-1488 Tri Angular Positioning Plate

