

LIPOSUCTION CANNULAS AND SETS



Cannulas for Iniltration | Cánulas de iniltración
Kanülen zur Iniltration | Canules pour l'iniltration



18-001
2mmØ
25cm
10holes

18-002
3 mm Ø
25 cm
10 holes

Cannulas
18-003
9 x 70 mm Ø
18-004
1 x 120 mm Ø
Packing unit 100 pieces, steril

Cannulas For Iniltration
Measurements = working length

18-005
Luer-Lock syringes
Adaptor with Luer-Lock connection, for use of
cannulas with handle connector on

18-006
Accessories for Syringes



18-007
2 mm Ø
15 cm
18 holes

Entner Cannulas



18-008
3 mm Ø
15 cm
18 holes

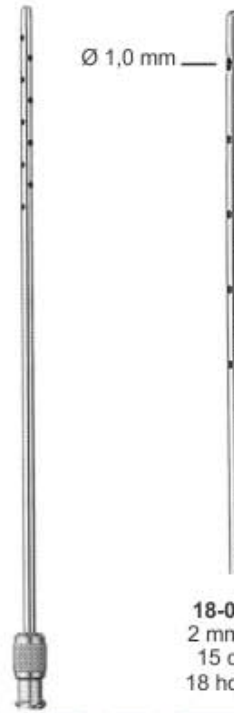

18-009
2 mm Ø
15 cm
18 holes

Entner Cannulas
Measurements = working length



18-010
3 mm Ø
15 cm
18 holes

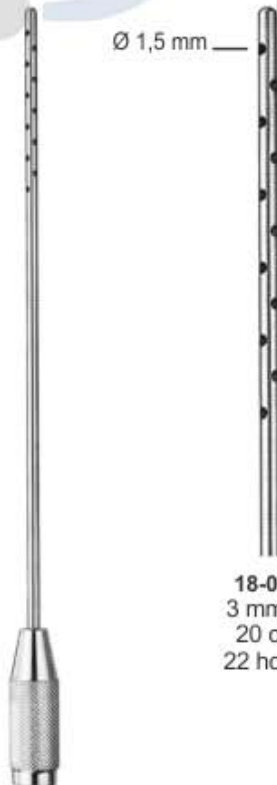

18-011
3 mm Ø
20 cm
22 holes

Entner Cannulas
Measurements = working length

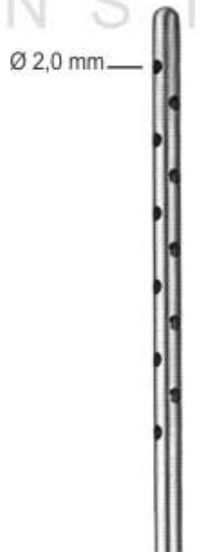

18-012
4 mm Ø
20 cm
22 holes



18-013
3 mm Ø
20 cm
22 holes

Entner Cannulas



18-014
4 mm Ø
20 cm
22 holes

Liposuction Cannulas | Cánulas de liposucción
 Liposuction-Kanülen | Canules pour liposuccion

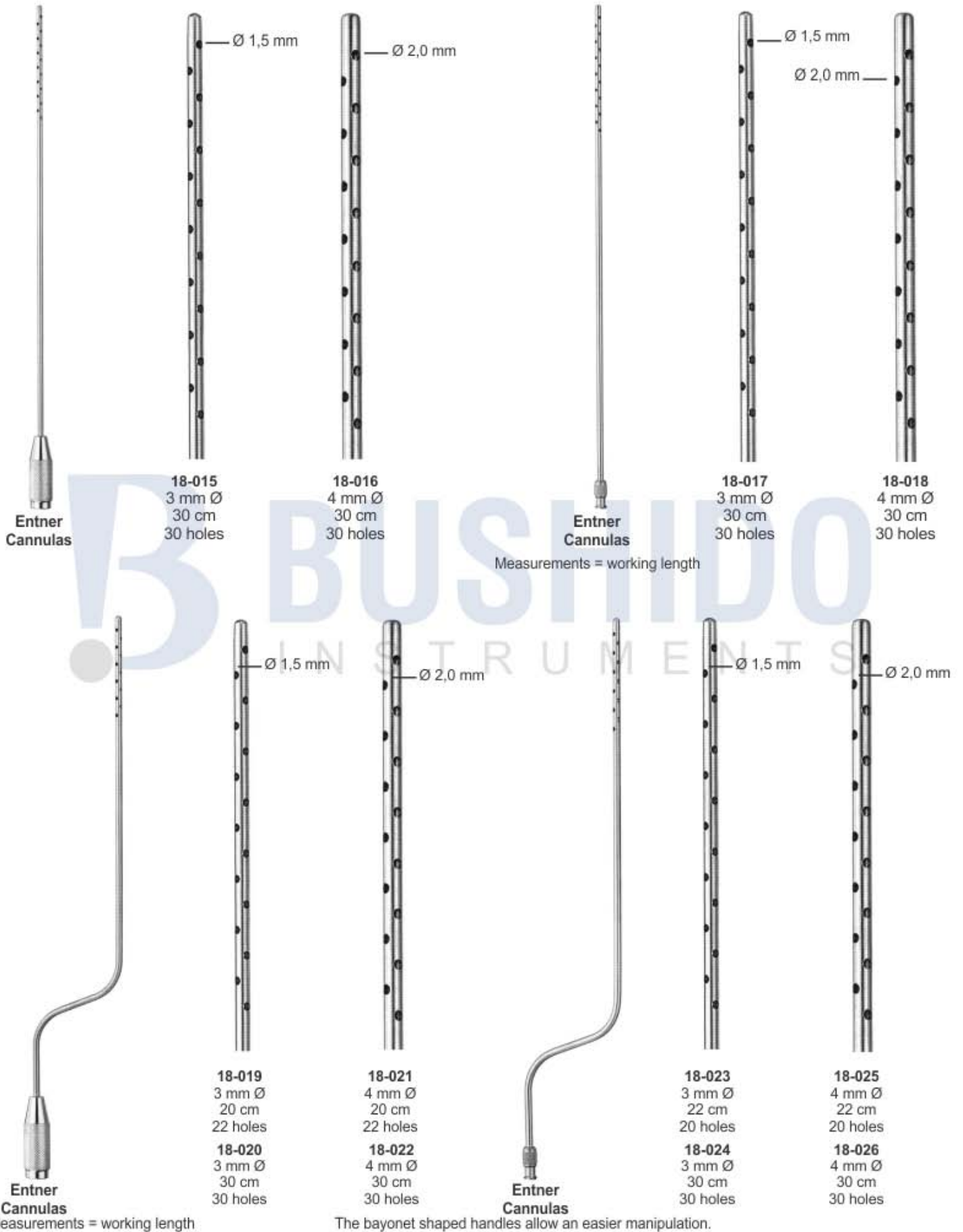

Measurements = working length

Measurements = working length

The bayonet shaped handles allow an easier manipulation.



Set Suggestions Liposuction Cannulas | *Proposiciones de juegos cánulas de liposucción*
 Setvorschläge Liposuction-Kanülen | *Propositions pour boîtes canules pour liposuccion*



Face Cannulas
18-031
15 cm
2 mm Ø



18-032
5 cm 1,7 mm Ø
18-033
15 cm 1,7 mm Ø



Neck Cannulas
18-034
15 cm
3 mm Ø



Neck Cannulas
18-035
20 cm
3 mm Ø



Neck Cannulas
18-036
15 cm
2 mm Ø



18-037
5 cm 2 mm Ø
18-038
5 cm 3 mm Ø
18-039
15 cm 2 mm Ø
18-040
15 cm 3 mm Ø



Thigh - Lower Leg Cannulas
18-041 20 cm 3 mm Ø
18-042 30 cm 3 mm Ø
18-043 20 cm 4 mm Ø
18-044 30 cm 4 mm Ø



Abdomen / Saddlebag Cannulas
18-045 20 cm 3 mm Ø
18-046 20 cm 4 mm Ø



Abdomen / Saddlebag Cannulas
18-047 30 cm 3 mm Ø
18-048 30 cm 4 mm Ø



18-049
with rotatable tube connection
Accessories

Fork shape, rounded tips, dissecting surface between tips / one central hole.



18-050
2 mm Ø
5 cm

18-051
2 mm Ø
15 cm



18-052
3 mm Ø
5 cm

18-053
3 mm Ø
15 cm



18-056
4 mm Ø
5 cm

18-057
4 mm Ø
25 cm



18-059
5 mm Ø
30 cm

18-054
3 mm Ø
25 cm

18-058
4 mm Ø
30 cm

18-055
3 mm Ø
30 cm

Toledo Cannulas
Measurements = working length



18-060
3 mm Ø
15 cm

18-061
3 mm Ø
25 cm



18-062
4 mm Ø
15 cm

18-063
4 mm Ø
25 cm



Turbo

18-064
3 mm Ø
30 cm



three lateral holes

The improved arrangement of the suction holes ensures a more effective and gentle suction in areas with much connective tissue and in case of gynecomasty.

Mercedes Cannulas

Measurements = working length

Kotzur Cannulas

Liposuction Cannulas
Liposuction-Kanülen

Cánulas de liposucción
Canules pour liposuccion



Cannulas



one central hole, two lateral holes
Measurements = working length



18-065
3 mm Ø
20 cm



18-067
4 mm Ø
30 cm



18-068
5 mm Ø
30 cm



18-069
6 mm Ø
30 cm

18-066
3 mm Ø
30 cm



18-070
3 mm Ø
20 cm



18-072
4 mm Ø
30 cm



18-073
5 mm Ø
30 cm



18-074
6 mm Ø
30 cm

18-071
3 mm Ø
30 cm



two lateral holes,
one central hole

Cannulas

Measurements = working length



18-075
3 mm Ø
20 cm

18-077
4 mm Ø
30 cm

18-079
5 mm Ø
30 cm

18-080
6 mm Ø
30 cm

18-081
4 mm Ø
30 cm

18-082
5 mm Ø
30 cm

18-076
3 mm Ø
30 cm

18-078
4 mm Ø
40 cm

Cannulas
three holes, diagonal
Measurements = working length

Cannulas
one central hole, two lateral holes
Measurements = working length



18-083
3 mm Ø
20 cm

18-084
3 mm Ø
30 cm

18-085
30 cm

6 mm

Cannulas
Point with hole, one lateral hole

Cannulas
Measurements = working length

Liposuction Cannulas

Cánulas de liposucción

Liposuction-Kanülen

Canules pour liposuction

For facial contouring:
one lateral hole



Cannulas
with handle connector



18-086
1,7 mm Ø
5 cm

18-087
1,7 mm Ø
15 cm



18-088
2 mm Ø
5 cm

18-089
2 mm Ø
15 cm



18-090
3 mm Ø
5 cm

18-091
3 mm Ø
15 cm



18-092
1,7 mm Ø
5 cm

18-093
1,7 mm Ø
15 cm

18-094
2 mm Ø
5 cm

18-095
2 mm Ø
15 cm

18-096
3 mm Ø
5 cm

18-097
3 mm Ø
15 cm

Cannulas
with Luer-Lock connection
Measurements = working length

Handles with connection thread for cannulas and hose connection 0 13 mm, for operation with a suction pump.

Recommended handles for the tumescence local anaesthesia technique
Hole for interrupting the suction process



18-098
Fix Handle



18-099
with rotatable tube connection
Handle



18-100
Fix Handle



18-101
with rotatable tube connection
Handle

Liposuction cannulas, stainless steel with thumb plate and hose connection Ø 13 mm, for use with a suction pump.

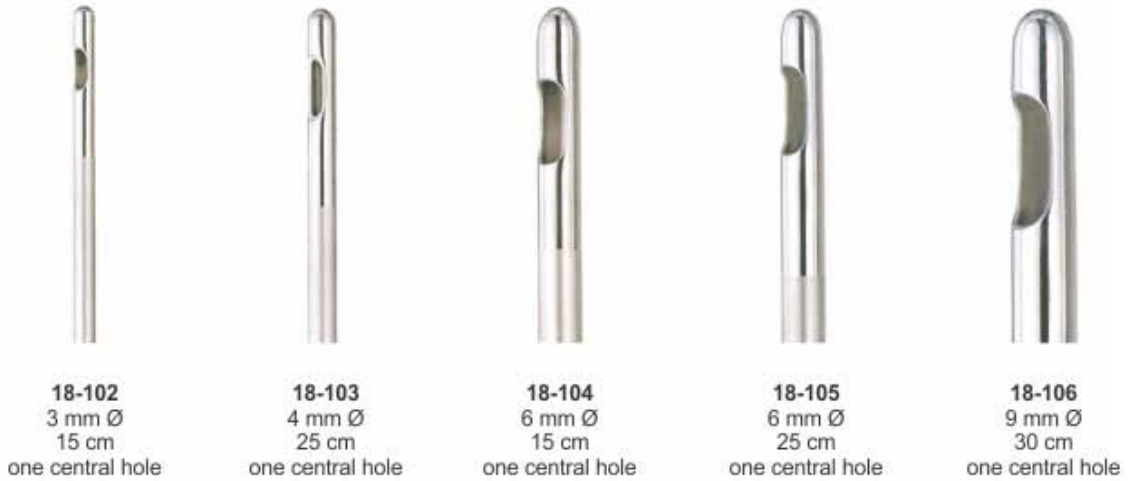

18-102 3 mm Ø 15 cm one central hole	18-103 4 mm Ø 25 cm one central hole	18-104 6 mm Ø 15 cm one central hole	18-105 6 mm Ø 25 cm one central hole	18-106 9 mm Ø 30 cm one central hole
--	--	--	--	--

Gasparotti Cannulas
Measurements = working length



18-107 4 mm Ø 15 cm two central holes	18-108 4 mm Ø 25 cm two central holes	18-109 6 mm Ø 30 cm two central holes
---	---	---

Gasparotti Cannulas
Measurements = working length

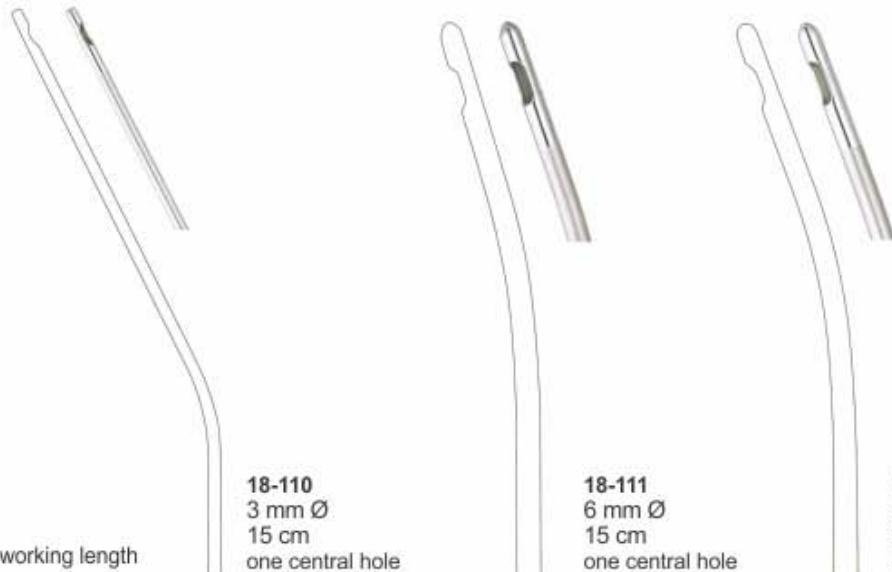

18-110 3 mm Ø 15 cm one central hole	18-111 6 mm Ø 15 cm one central hole	18-112 6 mm Ø 25 cm one central hole
--	--	--

Gasparotti Cannulas Measurements = working length

Liposuction Cannulas | Cánulas de liposucción
Liposuction-Kanülen | Canules pour liposuccion

Liposuction Cannulas Set



18-113
Liposuction Cannula Set for Abdomen and Saddlebag With Threaded Fitting
Liposuction Cannula with threaded connector, 22-Holes, diameter 3.0 mm, working length 20cm
Liposuction Cannula with threaded connector, 22-Holes, diameter 4.0 mm, working length 20cm
Liposuction Cannula with threaded connector, 30-Holes, diameter 3.0 mm, working length 30cm
Liposuction Cannula with threaded connector, 30-Holes, diameter 4.0 mm, working length 30cm
Liposuction Cannula Handle
Liposuction Cannula Handle with Interrupting Hole

18-114
Liposuction Cannula Set for Face with Luer Lock Fitting
Liposuction Cannula, with one central hole, diameter 1.7 mm, working length 5 cm
Liposuction Cannula, with one central hole, diameter 1.7 mm, working length 15 cm
Liposuction Cannula, 18-Holes, diameter 2.0 mm, working length 15 cm



18-115
Liposuction Cannula Set for Face with Threaded Fitting
Liposuction Cannula, with one central hole, diameter 1.7 mm, working length 5 cm
Liposuction Cannula, with one central hole, diameter 1.7 mm, working length 15 cm
Liposuction Cannula, 18-Holes, diameter 2.0 mm, working length 15 cm
Liposuction Cannula Handle
Liposuction Cannula Handle with Interrupting Hole

18-116
Liposuction Cannula Set for Neck
Liposuction Cannula with Luer-Lock, with one central hole, diameter 2.0 mm, working length 5cm
Liposuction Cannula with Luer-Lock, with one central hole, diameter 3.0 mm, working length 5cm
Liposuction Cannula with Luer-Lock, with one central hole, diameter 2.0 mm, working length 15cm
Liposuction Cannula with Luer-Lock, with one central hole, diameter 3.0 mm, working length 15cm
Liposuction Cannula with threaded connector, 18-Holes, diameter 3.0 mm, working length 15 cm
Liposuction Cannula with threaded connector, Angled, 22-Holes, diameter 3.0 mm, working length 20 cm
Liposuction Cannula with threaded connector, 8-Holes, diameter 2.0 mm, working length 15 cm
Liposuction Cannula Handle
Liposuction Cannula Handle with Interrupting Hole

Liposuction Cannulas Set

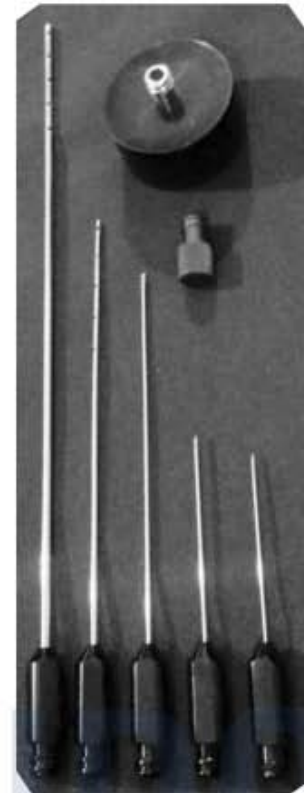

18-117

- Liposuction Cannula Set for Thie and Lower Leg with Threaded Fitting
- Liposuction Cannula with threaded connector, byonet shape, 22-Holes, diameter 3.0 mm, working length 20 cm
- Liposuction Cannula with threaded connector, byonet shape, 22-Holes, diameter 4.0 mm, working length 20 cm
- Liposuction Cannula with threaded connector, byonet shape, 30-Holes, diameter 3.0 mm, working length 30 cm
- Liposuction Cannula with threaded connector, byonet shape, 30-Holes, diameter 4.0 mm, working length 30 cm
- Liposuction Cannula Handle
- Liposuction Cannula Handle with Interrupting Hole

18-118

- Micro Fat Injection Cannulas Set
- Open Port Injector Cannula, 1.2mm, 10cm, Luer Lock
- Multi Holes Harvester Cannula Model 2, 2.5mm, 20cm, Luer Lock
- Tumescent Infiltrator Cannula, 1.5mm, 12cm, Luer Lock
- Micro Injector Cannula, 0.8mm, 4cm, Luer Lock
- Micro Injector Cannula, 1.0mm, 5cm, Luer Lock
- Holding Device
- Luer Lock Syringe Cap

Safe Cannula Set

18-119

- 1 TWO STANDARD HOLE LIPOSUCTION CANNULA, 3.5mm, 25cm, Super Handle
- 2 Mercedes Liposuction Cannula, 5.0mm, 30cm, Super Handle
- 3 Mercedes Liposuction Cannula, 4.5mm, 30cm, Super Handle
- 4 Mercedes Liposuction Cannula, 4.0mm, 25cm, Super Handle
- 5 Single Basket Liposuction Cannulas, 4.0mm, 30cm, Super Handle
- 6 Double Basket Liposuction Cannulas, 4.0mm, 30cm, Super Handle
- 7 Triple Basket Liposuction Cannulas, 4.0mm, 30cm, Super Handle
- 8 Spiral Three Port Harvester Cannula, 3.0mm, 20cm, Super Handle
- 9 Spiral Three Port Harvester Cannula, 4.0mm, 25cm, Super Handle
- 10 Three Port Harvester Cannula, Model 4, 4.5mm, 30cm, Super Handle
- 11 Three Ports Pyramid Cannula, 3.5mm, 25cm, Super Handle
- 12 Basket Cannula, 5.0mm, 32cm, Super Handle



Fat Injection Syringes

Fat Suction Syringes



18-120
Fat Injection Syringe
50ml



18-125
Fat Suction Syringe
50 ml



18-121
Universal Fat Injection syringe
20ml



18-126
Fat Suction Syringe
50 ml



18-122
Universal Fat Injection syringe
10ml



18-127
Fat Suction Syringe
20 ml



18-123
Fat Injection Syringes
0.1 ml per click
1 ml



18-128
Fat Suction Syringe
10 ml



18-124
Fat Injection Syringe
3 ml special
0.1 ml per click



18-129
Fat Suction Syringe
5 ml



18-130
Fat Suction Syringe
3 ml